

MESYS Shaft Calculation

Introduction

This shaft calculation (Version 04/2017, File version 3.0) calculates the deflections, internal forces and the natural frequencies of several shafts connected by boundary conditions. The following features are supported:

- Definition of multiple coaxial shafts is possible
- Definition of parallel shafts (with extension for shaft systems)
- Definition of shafts in arbitrary direction (with extension for advanced shaft systems)
- Shaft geometry is defined by cylindrical and conical elements
- Inner and outer geometry can be defined independently
- Shear deformation can be considered optionally
- A nonlinear shaft model can be used optionally
- The weight of the shaft can be considered optionally
- An arbitrary number of loads can be defined on each shaft either as point or line loads. Loads (without masses) may be defined outside of the shaft geometry also. Available loading elements are:
 - Force element with three components each for force and moment
 - Eccentric force element with three force components in polar coordinates
 - Helical Gear element using gear data and torque as input
 - Bevel/Hypoid Gear element using gear data and torque as input
 - Worm/Worm Gear element using gear data and torque as input
 - Coupling element for entering a torque only
 - Pulley element for torque and pretension
 - Mass elements for introducing weight and inertia for natural frequencies
 - Imbalance and dynamic force as periodic loads for harmonic response
- An acceleration can be defined for the system and is considered as inertia force
- An arbitrary number of boundary constraints can either be defined between a shaft and a rigid housing or between two coaxial shafts.
- Several housing stiffness matrices can be considered either with three or six degrees of freedom per node
- Import of shaft geometry as 2D DXF or 3D STEP file
- Strength calculation according DIN 743 (with extension for shaft strength)
- Connections by cylindrical gear pairs (with extension for shaft systems)
- Connections by bevel gear pairs (with extension for advanced shaft systems)
- Connections by worm-worm gears (with extension for advanced shaft systems)
- Planetary gear sets (with extension for advanced shaft systems)
- Centrifugal forces are considered on planet shafts
- Calculation of shaft speeds considering given constraints (with extension for shaft systems)

- Data exchange with several programs for gear calculation (with extension for shaft systems)
- Nonlinear rolling bearing stiffness can be considered
- Bearings can be selected from a database
- MESYS Rolling Bearing Calculation is fully integrated in the shaft calculation
- MESYS Ballscrew Calculation is fully integrated in the shaft calculation
- Calculation using load spectra
- Natural frequencies are calculated considering torsion, bending and axial modes (with extension for modal analysis)
- Campbell diagram (with extension for modal analysis)
- Harmonic response to periodic forces (with extension for modal analysis)
- Thermal expansions, optionally with varying temperature on a shaft
- Parameter variations
- 3D axisymmetric elastic parts considered by 3D FEA (with extension for 3D elastic parts)
- 3D-elastic planet carriers defined parametrically or imported as STEP file (with extension for 3D elastic parts)
- Import of housings as STEP file and consideration as stiffness matrix and optionally by modal reduction (with extension for 3D elastic parts)

Installation

When running the installer, the installation directory can be selected. The default location is “\Program Files\MESYS 04-2017”. All files are installed into that directory. Also an entry in the start menu is created.

The uninstaller can be called from the start menu. This deletes the installation directory and the entries in the start menu.

Without a license file the software runs as demo version. In the demo version it is not possible to save or load files and a Demo message is shown on each calculation. The demo version may only be used for evaluation of the software.

The license file ‘license.dat’ has to be placed in the installation directory (in the same directory as MesysShaft.exe). The name of the license file may not be changed since it will not be found by the software.

Configuration with INI-File

Some configuration of the software can be done using ‘mesys.ini’ in the installation folder.

Currently the settings are used for database access and formatting of the report.

Section	Value	Description
General	recentfilenumber	Number of recent files shown in the file menu of the software
	floatinglicense	Path to the licensing file for floating license. It will be written by the software but might be copied to other installations. Format: \\\\Server\\Share\\path\\license.lic Note: each ‘\’ has to be doubled

	floatingtimeout	Time in seconds after a floating license is release if the program is not used. Default is 1800
	fontsize	Fontsize in points, set 0 for default dependent on operating system
	style	Either windows, fusion, windowsxp.
	listseparator	Character used as separator for table export. If not set the default setting in operating is used
	systemlocale	Set to true for decimal point of operating system or false for '.' as decimal separator
	usecalculatethread	If set to true calculation is done in a separate thread, else set to false
	ffmpegpath	Path to the program ffmpeg to create videos from animations. It can found at www.ffmpeg.org For path separators either use '/' or '\\\' but not '\'
database	path	The path to the database file can be defined. The database can be copied onto a server, so all software users share the same database. If the filename is given without path, it is opened from the installation directory. For path separators either use '/' or '\\\' but not '\'
	iswritable	Set it to true if the database may be changed. If set to false no changes are made to the database by the software.
	usecache	If set to true the database is read to memory. This speeds up the program in case the database is on a network drive. Default is false.
importdatabases	path_1	A path to additional databases can be defined. These additional databases are read only and optionally encrypted. If the filename is given without path, it is opened from the installation directory. For path separators either use '/' or '\\\' but not '\'
	password_1	The password for the encrypted database
shaft	defaultinputs	Path to a xml-file with default settings For path separators either use '/' or '\\\' but not '\'
	calculateonfileload	If set to true the calculation is run when a file is loaded. Default is true.
	acceptfiledrop	If set to true a *.xml input file can be loaded by dropping it on the main window
	logo	A logo for use on the system page can be defined here. The format had to be PNG.
	numberofthreads	The number of threads that should be used in FEA calculations. The default is 2. More threads have only little impact on normal shaft calculations, but might be helpful in case of 3D-elastic parts.
report	format	The outputted report file can have different formats. By default, this value is equal to "INTERNALPDF", but it can be set to "DOCX", "DOC", "ODT" or "PDF" (without quotes)
	topmargin	The top margin for the report in mm
	bottommargin	The bottom margin for the report in mm
	leftmargin	The left margin for the report in mm
	rightmargin	The right margin for the report in mm
	papersize	The size of the paper for the report. Available values are

		A4 and Letter
	template	Path to the created template file used for the report creation. Supported file formats: "DOCX", "DOC" or "ODT"
	logo	A different logo can be defined, which will be used in the report. The format had to be PNG.
	marginbox1\active	The marginbox is used if set to true, else set it to false
	marginbox1\rect	The size of the marginbox is defined with values in mm. The format is @Rect(x1 y1 width height). The parameters x1 and y1 describe the upper left corner of the box. Positive values are measured from the top/left negative values from the bottom/right. For example @Rect(-35 -20 30 20) is a rectangle at the right bottom.
	marginbox1\text	The text for the margin box. It has to be set in quotations marks (like in "Text"). Either normal text or HTML can be used. Some placeholders are defined: #page, #pageCount, #data, #datetime
	marginbox1\angle	A rotation angle of the margin box can be set in degrees. The orientation of the angle is clockwise if positive.
	marginbox1\isHtml	Either set it to true or false dependent on the type of text.
	marginbox1\drawBox	If set to true a rectangle is drawn indicating the size of the marginbox. Else set it to false.
	marginbox2\...	Like for margin box 1 additional boxes can be defined with increasing numbers.

Please note that the listed options for margin boxes (marginbox1\...) are only valid if format is equal to "INTERNALPDF".

Template

As detailed in the table above, a template in (.docx) format can be created so that it is used when generating the software report. For the current version, only the information contained in the header and footer can be edited, in which it is possible to link information to the software such as 'module license', 'license name', 'date', 'file name', 'project name' or 'description' by means of the text fields option in Microsoft word. Additionally, a company logo can be included, instead of the MESYS logo that it is shown by default at the report:



«moduletitle»-«licensename»
Date: 2/27/2015 11:03:39 AM
File name: «filename»
Project name: «projectname»
Description: «description»

First Page Header

Field [?] [X]

Please choose a field

Categories: (All) [v]

Field names:

- Fill-in
- GoToButton
- GreetingLine
- Hyperlink
- If
- IncludePicture
- IncludeText
- Index
- Info
- Keywords
- LastSavedBy
- Link
- ListNum
- MacroButton
- MergeField**
- MergeRec
- MergeSeq
- Next

Field properties

Field name: description

Format:

- (none)
- Uppercase
- Lowercase
- First capital
- Title case

Field options

- Text to be inserted before: []
- Text to be inserted after: []
- Mapped field
- Vertical formatting
- Preserve formatting during updates

Description: Insert a mail merge field

Field Codes []

OK Cancel

Command line parameters

The software supports a few command line parameters:

- -disableHighDPI disables scaling and tell the operating system to do the scaling. This is currently the default setting.
- -enableHighDPI enables highDPI scaling by the software. This setting still has some problems but it might be useful on some systems.
- -desktopOpenGL tells the software to use hardware OpenGL, which is the default.
- -OpenGLES tells the software to translate OpenGL into DirectX. This can be used if the driver for the graphic card does not work correctly and hardware OpenGL does not work.
- -softwareOpenGL tells the software to use a software driver for 3D graphics. This can be used if the two setting above fail to work.
- -ini=file.ini tells the software to use 'file.ini' for program settings
- -license=license.dat tells the software to use 'license.dat' as license file. This can be used if different license files are available.
- If a *.xml filename is passed as a parameter, the file is opened by the software. This also allows to drop an input file on a program icon on the desktop.

Update

If the software is updated with a new version the database 'mesys.db' should not be overwritten. Either the new installation is done in a new directory or the database file is copied to a different location.

After the new version is started the database can be updated by choosing menu 'Extras'->'Database'->'Import from old database'. All custom entries will be updated. Changes to default data will be lost as only custom data will be copied.

Requirements

The shaft calculation is available as 32bit windows program running on Windows Vista, Windows 7, 8 or 10. In addition to the 32bit version which can be used on 32bit or 64bit operating system also a 64bit version is available. The minimum required processor is Intel Pentium 4 or above.



About 200MB of hard disk space is required. All dependencies of the software are available in the installation directory. Therefore, it can just be copied to other machines or started from network or removable disks.

General usage

To run a calculation first the data on all pages is introduced. Then press the button  or F5 to run the calculation. After all data is defined the calculation can be run from each page. So it is easy to make parameter variations.

There are some special buttons used in the user interface, which are explained in the following table:

Button	Explanation
	This plus button shows a dialog with additional inputs. Some of these

	inputs need to be defined, some are just optional.
	This conversion button allows the conversion from other types of input. For example, the radial clearance can be converted from an axial clearance
	This proposal button provides a suggestion for an input by the software

The unit system for the input and output can be selected on the menu 'Extras->Unit system' either as metric or US units. US units are not fully supported in the shaft calculation yet, only part of the inputs and outputs will be changed yet.

Using the context menu for the units of input fields, the current unit can be changed. These settings are not saved in the current version, so the change is only valid for the current session.

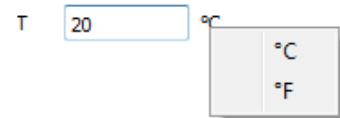

Pressing the right mouse button on an input field a window for an input of a formula is shown. This can be used for quick calculations.

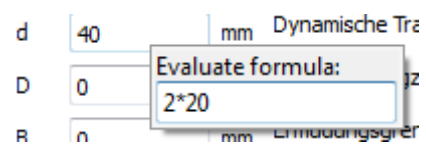

The software is available in English, German, French, Spanish, Chinese and Korean language. The language can also be selected in menu 'Extras'.

All graphics can be printed or exported as PNG file using the context menu (right mouse button) in the graphic window. For the export the size of the graphic can be specified.

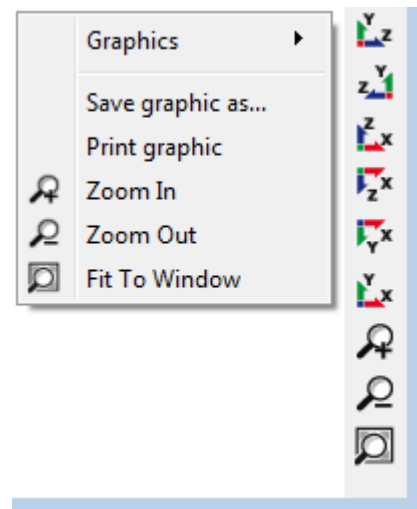

In the graphic windows of the software, there are different buttons for the view manipulation in 3D, such as the zoom-in, zoom-out and fit-to-window functions and also it is possible to select the point of view from different planes. The 3D model can be dragged with the mouse by holding down SHIFT key as well as zoomed in and out by holding down the CTRL key.

A 3D-mouse is supported in 3D-graphics.

Any diagram of the software can be edited by right clicking on it and selecting the 'Diagram options' at the context menu.

Both the units and bounds for the axes can be set. Moreover, if any of the graphs is of no interest, it can be disabled with the checkboxes. The color and line style of each curve can be changed too.

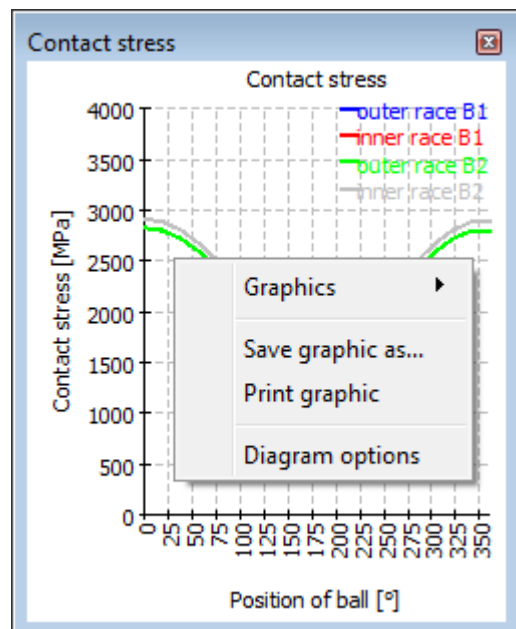

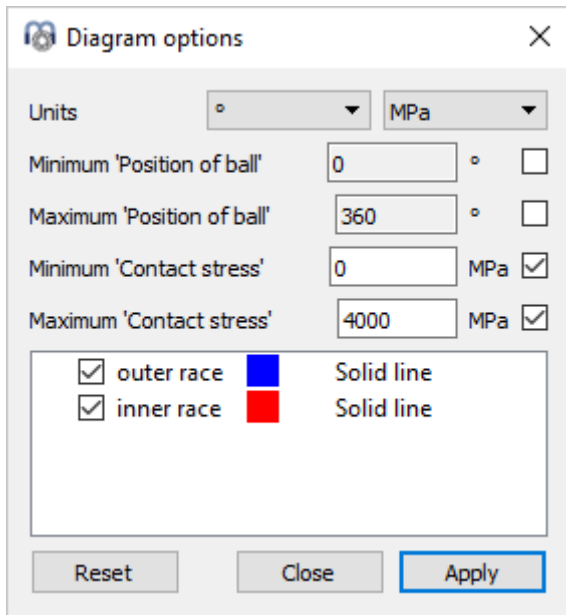

Units and precision of numbers in tables can be changed by right click on the header of a column.

Input Parameters

The input parameters are shown on several pages which can be selected in a System tree.

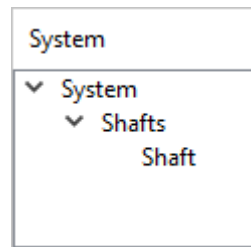

System Inputs

If the element 'System' is selected in the system tree on the left some general data can be defined.

mesys
Engineering Consulting Software AG

Shaft Calculation

Project name:

Calculation description:

Settings | Lubrication | Display settings

Consider weight

Angle for weight: β_w °

Calculate natural frequencies

Consider gyroscopic effect

Maximum frequency: f_{max} Hz

Number of frequencies: N_{freq}

Consider gears as stiffness

Consider gears as point load

Consider housing stiffness

Housing material: Steel

Housing temperature: T_h °C

Required life: H h

Bearing reliability: S %

Strength calculation: Infinite life according DIN 743

Bearing position: Definition for each bearing

Shear deformations: According Hutchinson

Consider nonlinear shaft model

Consider load spectrum

Calculate modified bearing life

Project name and calculation description

The project name and the calculation description are just inputs which are shown in the report header. They can be used to enter information about the purpose of the calculation for documentation.

Settings

Consider weight

The weight of shafts and additional masses is considered in the calculation if this setting is set.

Accelerations

The -button next to the weight checkbox allows the definition of global accelerations for the three axes.

The weight is already considered by setting the flag “Consider weight”. It does not have to be entered as acceleration. The input for accelerations is thought for additional accelerations like in gearboxes in vehicles.

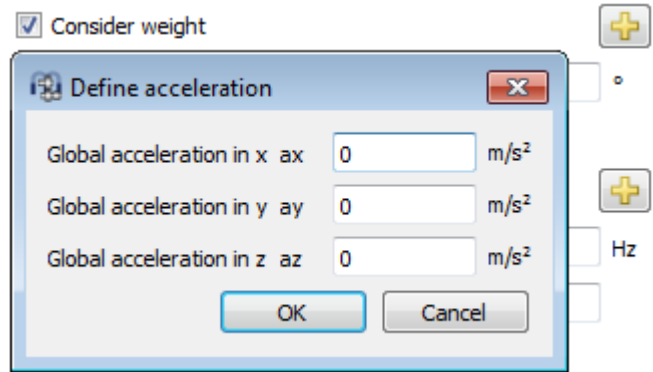

Angle for weight

The direction of the weight can be defined by this setting. The angle is in the x-y-plane, a rotation around z-axis. A value of zero results in a weight in the direction of shaft axis.

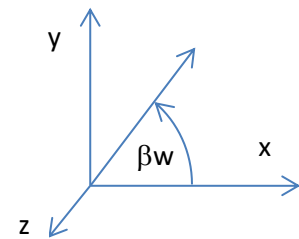

Calculate natural frequencies

The calculation of natural frequencies can be activated here. Running a calculation is faster if natural frequencies are not calculated.

Consider gyroscopic effect

If this setting is activated a gyroscopic matrix is considered in the calculation of natural frequencies. The mass inertia around x-axis and the speed of the shaft are required for this gyroscopic matrix.

The -button allows some additional inputs for the Campbell diagram:

- The diagram is generated for speeds between start and end factor times the current input value for speed.
- The number of speeds is the number of calculation points. Reduce it for faster calculation.
- The number of harmonics shows additional lines for multiples of shaft speed.
- The accuracy for critical frequency is a tolerance for calculation of critical speeds as intersections of shaft speed and natural frequency.
- If ‘Increase accuracy for mode changes’ is selected additional points are calculated when an axial mode changed into a radial mode for example.
- If ‘Calculate critical frequencies’ is selected the critical frequencies are calculated when the Campbell diagram is shown. Else it is only calculated for the report of critical speeds.

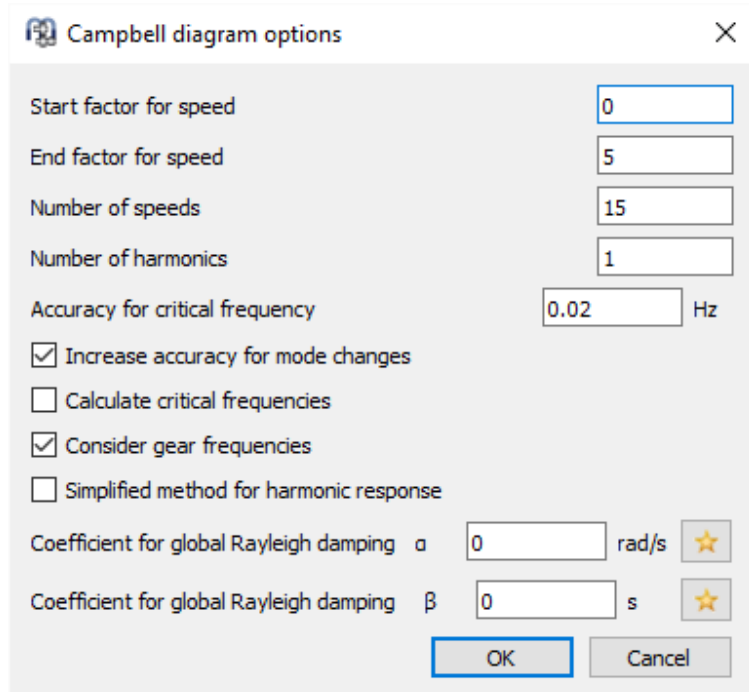

- If 'Consider gear frequencies' is selected additional lines for gear tooth frequencies are shown and the corresponding critical frequencies are calculated.
- If the simplified method for harmonic response is activated, the harmonic response is calculated as superposition of mode shapes. The accuracy of the solutions depends of the calculated number of mode shapes in this case. For large systems the calculation can be faster if the option is activated. The result is more accurate if it is not activated.
- Coefficients for global Rayleigh damping are used to define a global damping matrix as $D=\alpha*M+\beta*K$ using the global mass matrix M and the global stiffness matrix K. Using the sizing button, the values can be calculated so that a user defined damping ratio will result for two given frequencies.

Maximum frequency

The maximum value for natural frequencies that are of interest can be entered here.

Number of frequencies

The number of natural frequencies that should be calculated can be specified here. Normally only the first few modes are interesting. Both limits, the number of frequencies and the maximum are considered. If the Campbell diagram shown not enough lines these restrictions are often the reason.

Housing material and housing temperature

The material data of the housing is used together with the temperature of the housing to calculate the axial displacement for boundary conditions connected to the housing. For the shaft calculation only the thermal elongation coefficient is important, the other data is only used to transfer it to the bearing calculation.

Required life

The required life is passed to gear calculations which are connected to the system, and it is used for the shaft strength calculation.

Bearing reliability

The bearing reliability can be optionally defined on system level and is then passed to all bearing calculations.

Strength calculation

The method for shaft strength calculation can be selected. Currently only DIN 743 (2012) is available. It can be selected if the calculation should be done considering infinite or finite life. For finite life the number of cycles is calculated using the input for "Required life".

Shear deformations

Shear deformation should normally be taken into account, since there are these deformations. For comparison with other calculations the shear deformations can be ignored. For nonlinear shaft model the shear deformations should be considered to improve convergence.

There are different options available. Either a fixed value can be entered. Usually 1/1.1 is used for cylinders. The option 'according Cowper' and 'according Hutchinson' are also considering an inner diameter for hollow shafts and the Poisson number of the material. Hutchinson considers higher order terms in his formula than Cowper according to (Hutchinson, January 2001) (Cowper., June 1966):

- Hutchinson (Circular Cross Section):

$$k = \frac{6(1 + \nu)^2}{7 + 12\nu + 4\nu^2}$$

- Hutchinson (Hollow Circular Cross Section):

$$k = \frac{6(a^2 + b^2)^2(1 + \nu)^2}{7a^4 + 34a^2b^2 + 7b^4 + \nu(12a^4 + 48a^2b^2 + 12b^4) + \nu^2(4a^4 + 16a^2b^2 + 4b^4)}$$

where b is the outer radius, a the inner radius and ν the Poisson's ratio.

- Cowper (Circular Cross Section):

$$k = \frac{6(1 + \nu)}{7 + 6\nu}$$

- Cowper (Hollow Circular Cross Section):

$$k = \frac{6(1 + \nu)(1 + m^2)^2}{(7 + 6\nu)(1 + m^2)^2 + (20 + 12\nu)m^2}$$

where $m = b/a$ is the ratio of inner to outer radius and ν the Poisson's ratio.

Consider nonlinear shaft model

A nonlinear shaft model can be taken into account. The nonlinear model calculates equilibrium of loads in the deformed state.

A beam fixed on one side and radially loaded on the other side will show only radial deflections in the linear model. In the nonlinear model the end point will also move axially and the length of the beam will not increase. A beam fixed on both sides will show an increased stiffness against loading in the center, the stiffness will increase with the loading because of generated axial loads. The nonlinear model is only needed on large deflections; normal shafts in mechanical engineering do not require a nonlinear model.

Currently the nonlinear shaft model cannot be used together with the calculation of natural frequencies if thermal stresses are considered.

Consider load spectrum

If a load spectrum should be taken into account, select this option. An additional item for the load spectrum will be shown in the tree on the left.

Consider gears as stiffness

If this option is selected the shaft diameter is increased to root diameter plus 0.4*module automatically. For the root diameter a dedendum of the reference profile of 1.25 is assumed.

Consider gears as a point load

If this option is selected, the load line from the meshing of gears is converted to a point load. This is useful for calculating bearing loads when the user wants to consider perfectly centered gears loads, that is, no misalignments in tooth mesh.

Calculate modified bearing life

This setting is passed on to the bearing calculation and activates or suppresses output of modified life in results. It can be disabled if no information about lubrication is available.

Consider configurations

If multiple groups are used an additional option is shown to activate configurations. Using the new input page for configurations the status of connections can be changed to allow different options for power flow.

Lubrication

The data for lubrications is only to transfer it to bearing or gear calculations. For details regarding the inputs please consult the documentation of the rolling bearing calculation. The 'FZG load stage' is an additional input which is passed to a gear calculation.

Display settings

There are different view options that can be set under the tab-page 'Settings'.

Cutaway in 3D: It is possible to generate a cutaway view for all the existing shafts. If needed, the cutaway can be only applied to the hollow shafts.

With regard to the 3D animation settings, both the frequency for modes shapes and the rotation speed are adjustable. The 3D pressure distribution of the bearings can be easily exaggerated with a

scale factor 'Sp'. And with the 'Su' the deformed shape in 3D can be also scaled. The look of the shaft geometry in 2D can be emphasized by applying a lighting factor 'fl'. The factor 'fld' is used for the shaft background graphic in 2D diagrams.

The input value for sigV allows the user to specify the maximum permissible stress that any shaft shall reach under loading. In this way, the software shows graphically an approximation of required diameter of the shafts subjected to a maximum value of equivalent stress. Please refer to the 'Graphics area' section of this document on how to visualize the required diameter diagram.

Colors for bearings can be specified on the right of the dialog. The left button is for bearings which are connected to one shaft and the housing while the right button is for bearing connected to two shafts.

In addition, a default color for shafts and gears can be defined.

Definition of shafts

In the System-tree using a right click on “Shafts” additional shafts can be added to the system. The shaft can be defined by selecting it in the system tree.

Either shafts can be directly added, if only single or coaxial shafts are used. For general shafts systems groups or coaxial groups can be used to build shaft systems. Planetary groups are used for planet shafts to model planetary gear sets.

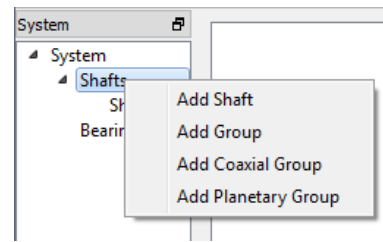

General shaft data

On the first page “General” some general data and data for the strength calculation can be defined for each shaft.

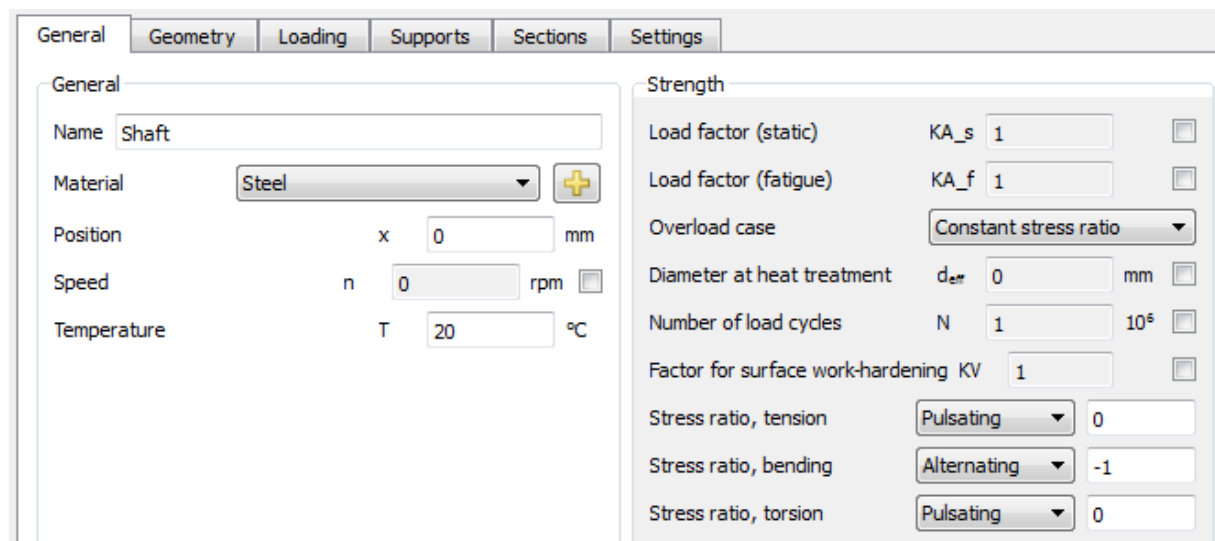

Name

A name for each shaft can be defined which is used in the system tree, messages and the report to identify the shaft.

Material

The material can be selected from the data base. The -button allows to see the material data or to change the data if user-input is selected.

Position

If several shafts are defined they can have different axial positions. The value for position defines the position of the start point or the left end of a shaft relative to the group. All loads and boundary conditions are then defined relative to this start point.

Speed

The rotation speed of the shaft has an influence on bearing life and natural frequencies with gyroscopic effect. If the checkbox behind the input is not selected, the software is trying to calculate it using constraints. It is set to zero if the shaft is not connected to others.

Temperature

The temperature of the shaft can be defined here. The temperature is transferred to the bearing calculation and will induce axial stresses into the shaft.

In case that the shaft temperature is not uniform, the user must set the flag corresponding to 'Consider temperature per element' at the tab-page 'Settings'. That allows the user to add a temperature difference ' ΔT ' (\pm) for each element created at the outer geometry on the temperature previously set at the tab-page 'General'. The reference temperature with no stress field is 20°C.

Data for strength calculation

There are several inputs for the strength calculation according DIN 743 which are defined for each shaft.

Load factor (static)

For the calculation of static safety factor, the maximal load is multiplied with the static load factor.

Load factor (fatigue)

For the calculation of safety factor against fatigue the maximal load is multiplied with the load factor (fatigue).

Overload case

The overload case defines how the permissible stress is calculated. Either "Constant stress ratio" or "Constant mean stress" can be selected. "Constant stress ratio" leads to smaller safety factors and is therefore on the save side.

Diameter at heat treatment

The diameter at heat treatment is used to calculate the tensile strength and the yield point for the given material. The software sets it to the maximum shafts diameter automatically, but for hollow shafts the wall thickness can be chosen manually, if heat treatment was done for the hollow shaft.

Number of load cycles

If a calculation for finite life is done, the number of load cycles is derived from rotation speed and required life as default. But for non-rotating shafts this is not possible. Then the number of load cycles can be entered manually.

Factor for surface hardening

In DIN 743 a factor for surface hardening KV increases permissible stress. It can be set for hardening or mechanical treatment like shot-peening. As the standard provides a wide range for this value it has to be defined by the user.

Stress ratio

The stress ratio R is usually defined as minimum stress value divided by maximum stress value, which leads to values between $-\infty$ and +1.

The software is using a value between -1 and +1 instead and it defines the stress ratio using the following definition:

$$R = \begin{cases} \frac{\sigma_1}{\sigma_2}, & |\sigma_2| < |\sigma_1| \\ \frac{\sigma_2}{\sigma_1}, & |\sigma_1| < |\sigma_2| \end{cases}$$

Using this definition $R = 0$ can be used for pulsating loads between zero and a positive or a negative value. For alternating load $R = -1$ and for constant load $R = +1$.

The stress ratio can be defined for tension, bending and torsion independently. For a rotating shaft the stress ratio for bending should usually be -1. If the stress ratio for torsion is not given make a calculation with two cases: constant and pulsating for example. It depends on the current loading which case is conservative.

Geometry data

The geometry data of a shaft is defined on page "Geometry". The geometry can be defined using cylindrical and conical elements for outer and inner geometry.

Outer Geometry			Inner Geometry		
L=90mm			L=90mm		
Length [mm]	Diameter 1 [mm]	Diameter 2 [mm]	Length [mm]	Diameter 1 [mm]	Diameter 2 [mm]
1 20	20		1 40	10	
2 40	30		2 10	10	5
3 20	20		3 40	5	
4 10	20	10			

There is an input table for both inner and outer geometry. The plus- and minus-buttons allow adding and removing rows, the arrows can be used to move an element up or down in the table.

Length and diameter 1 have to be defined for each element. If diameter 2 is left empty a cylinder is used else a cone. No negative values are permitted. The total length is shown above the table.

If a hole from the right shall be defined as inner geometry, enter a first element with diameter zero to get to the start position on the hole.

The table for outer geometry also allows an input for a temperature difference if the corresponding option under settings is activated

Loading

Loads can be defined on the page “Loading” for each shaft. Loads may be defined outside a shaft; masses may not be outside of a shaft. Loads can also be changed by double clicking them in the graphics.

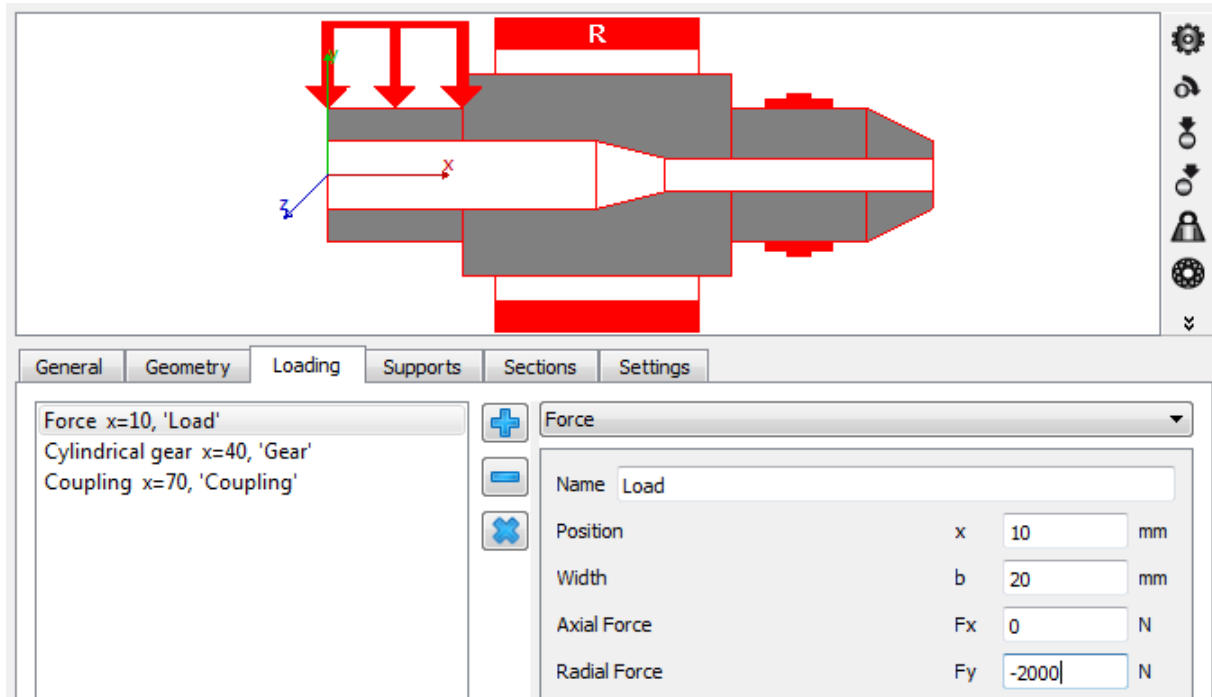

Loads can be added by the plus button next to the list. The type of the loading can be selected using the list on the right. Each load element has a name to identify it, a position relative to the left end of the shaft and a width.

The graphical representation just shows a symbol for the load, not the actual direction, as it can have six components. The coordinate system is shown on the right. The shaft axis is in x-direction, the y-axis goes up and the z-axis to the front. The weight is in negative y-directions a default (angle $\beta_w = -90^\circ$).

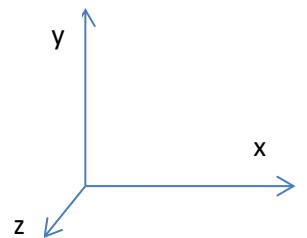

Force

The load element “Force” allows the definition of a force and a moment with three components each. The moments are moments around an axis. So F_x is the axial force and M_x is the moment around the x-axis so it is a torque.

Coupling

The coupling only allows a definition of a torque. The direction on the torque can either be defined by its sign or by the selection “Shaft is driven” (torque has the same sign as the rotation speed) or “Shaft is driving” (torque has different sign than the rotation speed).

Cylindrical gear

The load can be defined by entering data for a cylindrical gear and a torque.

The direction of torque can either be defined by its sign or by the selection “Shaft is driven”/“Shaft is driving”. The contact point is

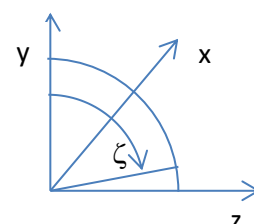

given by an angle of contact, which is zero on the y-axis and 90° on the z-axis.

The gear is defined by the usual data on a gear drawing: Number of teeth, normal module, normal pressure angle, helix angle with its direction. Optional inputs are the number of teeth for the mating gear and the center distance. If they are given the loads are calculated for the operating center distance, which is more accurate than on the reference diameter.

For internal gears the number of teeth has to be entered as negative value, the center distance is always positive as defined in ISO 21771 for gear geometry.

Bevel gear

The load can be defined using torque and geometry data for a bevel or hypoid gear.

The direction of torque can either be defined by its sign or by the selection “Shaft is driven”/“Shaft is driving”. The contact point is given by an angle of contact, which is zero on the y-axis and 90° on the z-axis.

Either the pitch angle can be defined directly or it is calculated using axis angle and number of teeth of the mating gear.

Instead of the mean normal module the outer pitch diameter can be used as an input.

The width is the width of the gear (the length of the flank), the axial length of the loaded shaft is smaller dependent on the pitch angle.

Name	Gear	
Position	x	40 mm
Width	b	30 mm
Torque	T	0 Nm
Direction of torque	Own Input	
Angle to contact	ζ	0 °
Number of teeth	z	25
Normal module	mn	2 mm
Normal pressure angle	α_n	20 °
Helix angle	β_n	0 °
Helix direction	Spur gear	
Number of teeth of mating gear	z2	25
Center distance	a	50 mm

Name	Bevel gear	
Position	x	40 mm
Width	b	20 mm
Torque	T	0 Nm
Direction of torque	Own Input	
Orientation	Apex on the right	
Angle to contact	ζ	0 °
Number of teeth	z	25
Normal module	mn	2 mm <input checked="" type="radio"/>
Pitch diameter	de	64.1421 mm <input type="radio"/>
Profile shift coefficient	x	0
Generated pressure angle	α_{rD}	20 °
Generated pressure angle	α_{rC}	20 °
Helix angle	β_m	0 °
Helix direction	Spur gear	
Pitch angle	δ	45 ° <input type="checkbox"/>
Number of teeth of mating gear	z2	25
Axis angle	Σ	90 °
Center distance	a	0 mm

Worm

The load can be defined using torque and geometry data for a worm.

The direction of torque can either be defined by its sign or by the selection “Shaft is driven”/Shaft is driving”. The contact point is given by an angle of contact, which is zero on the y-axis and 90° on the z-axis. The gear is defined by the usual data on a gear drawing: Number of teeth, axial module, normal pressure angle, lead angle with its direction. The gear friction coefficient, μ_z , can be set for the gear contact.

Worm gear

The load can be defined using torque and geometry data for a worm.

The direction of torque can either be defined by its sign or by the selection “Shaft is driven”/Shaft is driving”. The contact point is given by an angle of contact, which is zero on the y-axis and 90° on the z-axis. The gear is defined by the usual data on a gear drawing: Number of teeth, transverse module, normal pressure angle, helix angle with its direction. Optional inputs are the number of teeth for the mating gear and the center distance. The gear friction coefficient, μ_z , can be set for the gear contact.

Eccentric force

The eccentric force allows entering a force with three components at a point which is not on the shaft axis. The point and the force are defined in polar coordinates. The angle is defined in the same way as the angle of contact in the cylindrical gear (see above).

The radial force is positive if away from the shaft center, the tangential force is positive in the direction of the angle. Moments are calculated by the points and forces given.

Mass

Additional mass can be defined using the “Mass” element. In addition to its mass also the mass moment of inertia around three axes can be defined. The weight of the mass is considered and it is considered in the calculation of natural frequencies.

If a width is entered the mass is equally distributed on this line. The total mass inertias of this distributed mass are the input values, which results in a minimum value for J_{yy} and J_{zz} . A message will be shown if the input values are too small.

Name	Worm	
Position	x	1500 mm
Width	b	200 mm
Torque	T	0 Nm
Direction of torque	Own Input	
Angle to contact	ζ	0 °
Number of teeth	z	1
Axial module	m_x	20 mm
Normal pressure angle	α_n	20 °
Lead angle	γ_m	5 °
Helix direction	Helix left hand	
Gear friction coefficient	μ_z	0

Name	Worm gear	
Position	x	500 mm
Width	b	200 mm
Torque	T	0 Nm
Direction of torque	Own Input	
Angle to contact	ζ	0 °
Number of teeth	z	40
Transverse module	m_t	20 mm
Profile shift coefficient	x	0
Normal pressure angle	α_n	20 °
Helix angle	β_m	5 °
Helix direction	Helix left hand	
Gear friction coefficient	μ_z	0

Mass		
Name	Mass	
Position	x	0 mm
Width	b	0 mm
Mass	m	0 kg
Mass moment of inertia	J_{xx}	0 kg m ²
Mass moment of inertia	J_{yy}	0 kg m ²
Mass moment of inertia	J_{zz}	0 kg m ²
Eccentricity	e	0 mm
Phase	φ	0 °

If the added mass has an eccentricity, it will cause rotating unbalance and can be considered as a harmonic force according to the formula: $F = me_{cc}\omega^2 \cdot e^{i(\omega t + \varphi)}$ (e_{cc} : eccentricity in mm). A phase shift, φ ($^\circ$), for the imbalance force can be also taken into account.

Imbalance

If an imbalance should be only considered as a force with adding mass to the shaft, this element has to be used. The imbalance force will be then also regarded as a harmonic force and calculated in the same way as with an eccentric mass, that is: $F = me_{cc}\omega^2 \cdot e^{i(\omega t + \varphi)}$, but the inertia and the natural frequencies of the shaft will remain unaffected.

Imbalance			
Name	Imbalance		
Position	x	0	mm
Mass	m	0	kg
Eccentricity	e	0	mm
Phase	φ	0	$^\circ$

Dynamic force

This element allows the user to consider harmonic loads (moments or forces) on a shaft according to: $F = \bar{F} \cdot e^{i(\omega t + \varphi)}$. In case that the frequency is not the same as the one corresponding to the shaft speed, then it can be manually specified by checking the box next to the Frequency at the software dialog. A phase shift can be defined for the force as well.

Dynamic force			
Name	Dynamic force		
Position	x	0	mm
Axial Force	Fx	0	N
Radial Force	Fy	0	N
Radial Force	Fz	0	N
Torque	Mx	0	Nm
Bending moment	My	0	Nm
Bending moment	Mz	0	Nm
Frequency	f	0	Hz <input type="checkbox"/>
Phase	φ	0	$^\circ$

Pulley

The load can be defined defining a torque on the pulley and its pretension coming from a belt.

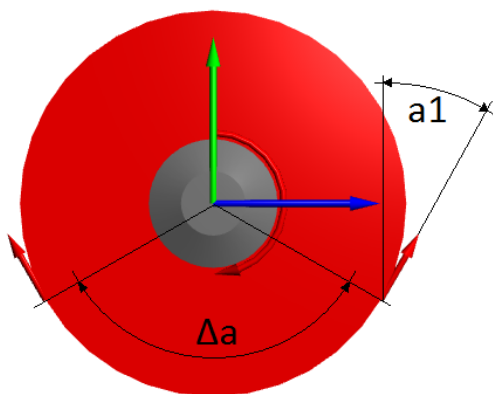

Pulley			
Name	Pulley		
Position	x	40	mm
Width	b	10	mm
Pretension force	Fpre	20	N
Torque	T	200	Nm
Direction of torque	Shaft is driving		
Angle of first force	α_1	30	$^\circ$
Wrap angle	$\Delta\alpha$	120	$^\circ$
Diameter	d	60	mm <input checked="" type="radio"/>
Number of teeth	z	0	<input type="radio"/>
Pitch	p	0	mm

The direction of torque can either be defined by its sign or by the selection "Shaft is driven"/"Shaft is driving". The positioning of the contact surface is given by an angle of first contact, which starts clockwise from zero on the y-axis, and followed by the wrap angle as shown in the picture below. The pulley diameter can be set straight away or by means of its teeth number and pitch.

A torque will lead to an increase force on one side of the belt and to a decreased force on the other side. This is the correct model in case no tensioning pulley is used.

Supports

Boundary conditions can be defined on the page “Supports”. They can also be edited by a double click in the graphics. Support elements including rolling bearings only define boundary conditions, they have no mass or weight.

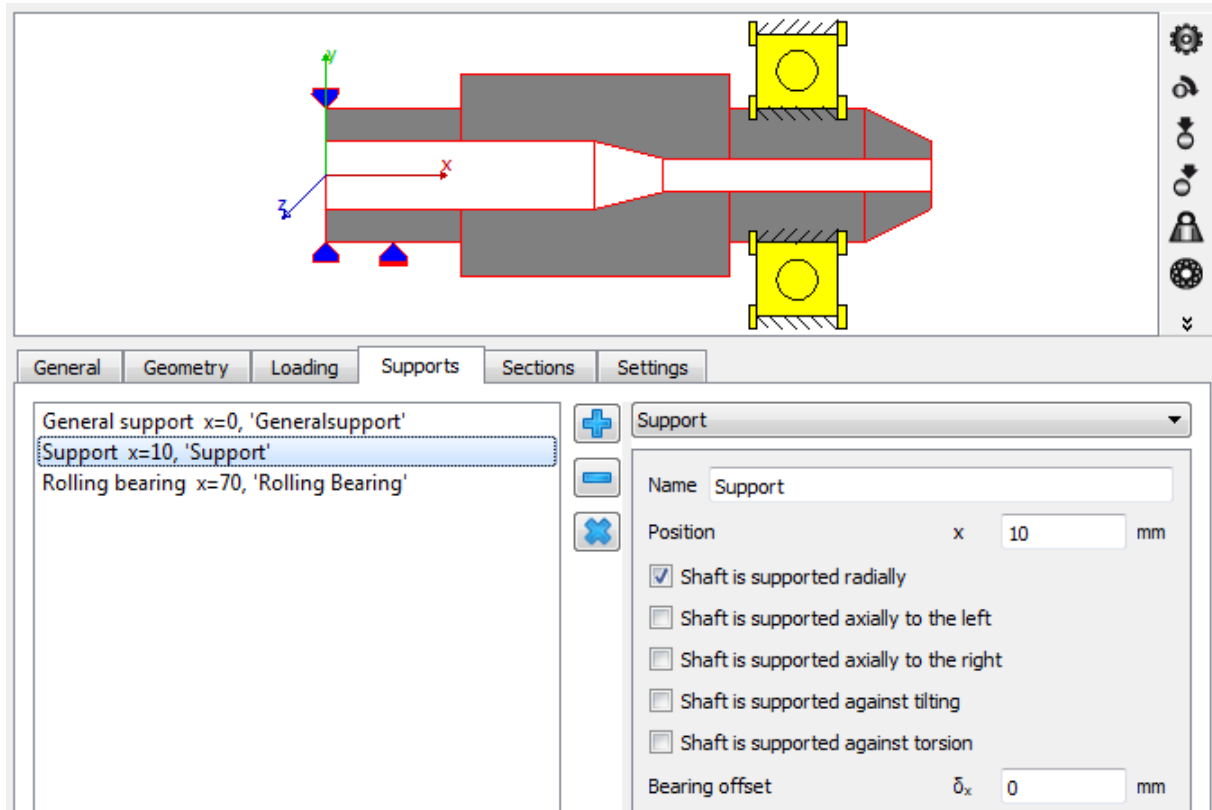

Support

The “Support” element is an easy to use element which allows defining constraints between the shaft and the housing. There are five checkboxes to define in which directions the shaft is supported. For axial direction the movement to the right and to the left can be constrained independently.

A bearing offset can be defined for the three directions. An offset means that the point on the housing is moved in this direction. The resulting force on the shaft is in the direction of the offset.

General support

The “General support” allows the definition of constraints between a shaft and the housing or between two shafts for all six degrees of freedom independently.

First a selection can be done to which element the shaft is connected to. It can be the housing or a second shaft.

For each degree of freedom, a type of constraint can be defined then:

No constraint

No constraint in the direction is defined.

Fixed

The degree of freedom between both elements is coupled in both positive and negative direction. An offset or a clearance can be defined optionally.

A positive value for the offset results in a movement of the current shaft in this direction, or a force on the selected shaft in this direction.

The clearance is either zero or a positive value, it may not be negative.

Fixed to the left/Fixed to the right

The selection “Fixed to the left” means than the selected shaft is constrained only in the negative direction (left on a horizontal axis).

“Fixed to the right” is the constraint in positive direction only. For the unidirectional constraint an offset can be defined.

Stiffness

The “Stiffness” acts like a spring. An offset and a clearance can be defined. Offset and clearance are defined as explained for ‘Fixed’ above.

Stiffness to the left/Stiffness to the right

Like the rigid constraint also stiffness can be defined in just one direction. The stiffness and an offset can be defined.

General constraint

Name General Constraint

Position x 0 mm

Connect to housing

Translation in x-direction

Type No constraint

Translation in y-direction

Type Fixed

Offset Δ_y 0 mm

Clearance Δ_y 0 mm

Translation in z-direction

Type Fixed to the left

Offset Δ_z 0 mm

Rotation around x-axis

Type Stiffness

Stiffness c_{rx} 0 Nm/r

Offset Δ_{rx} 0 rad

Clearance Δ_{rx} 0 rad

Rotation around y-axis

Type Stiffness to the left

Stiffness c_{ry} 0 Nm/r

Offset Δ_{ry} 0 rad

Rotation around z-axis

Type No constraint

Rolling bearing

The element “Roller bearing” defines a connection to the rolling bearing calculation.

The current shaft can be connected to the inner or to the outer ring of a roller bearing. The other ring of the bearing can be connected to either the housing or another shaft.

By clicking on the button “‘Geometry, Material, Temperature, Lubrication’ is connected” the user is prompted, by means of a pop-up window, to set those flags of the data to be transferred to bearing calculation. Shaft diameters, material data, lubrication and temperature data can be transferred to the bearing calculation. Displacements, loads and speeds are always connected.

The shaft is can be supported radially and axially to the left and the right. This setting changes the connection of the bearing outer ring to the shaft/housing. If the bearing cannot constrain a certain movement, there won't be reaction forces in that direction.

The bearing offsets will again generate forces to the current shaft in the direction of the offset. The offset can be used to generate bearing pretension in axial direction or to take misalignments of the housing into account.

If a rolling bearing element is added an entry for the bearing in the system-tree will be added. If this element is selected the dialogs of the rolling bearing calculation are active to define the bearing.

Using the -button next to the bearing type a dialog is shown to select a rolling bearing from the database.

Selecting bearing from database

The standard interface of the rolling bearing calculation software is shown for selection of a rolling bearing. Either a bearing is selected from the database or custom input is selected. Restrictions to inner and outer diameter can be applied if the bearing is selected from the database; the shaft diameter at the bearing position is set as default value.

For angular contact bearings or taper roller bearings the direction of contact angle can also be defined at the bottom of the dialog.

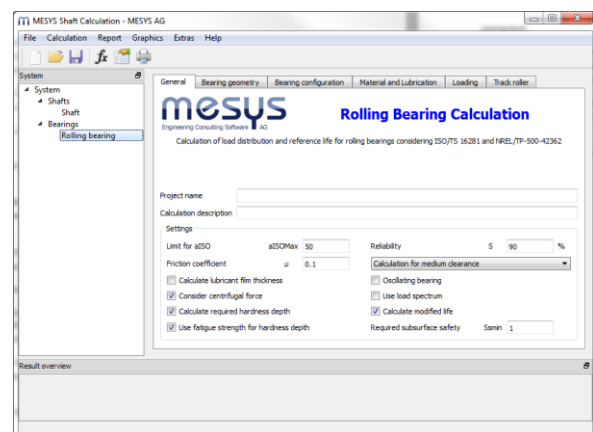
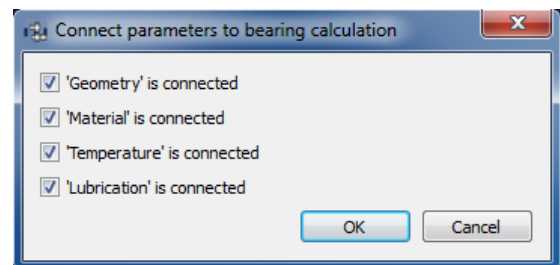
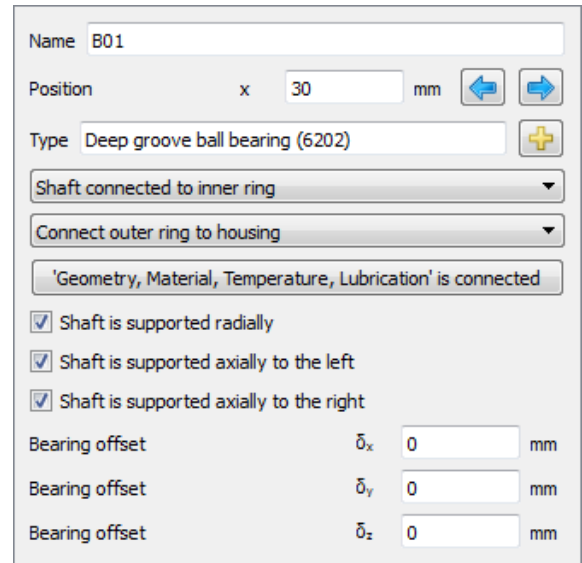

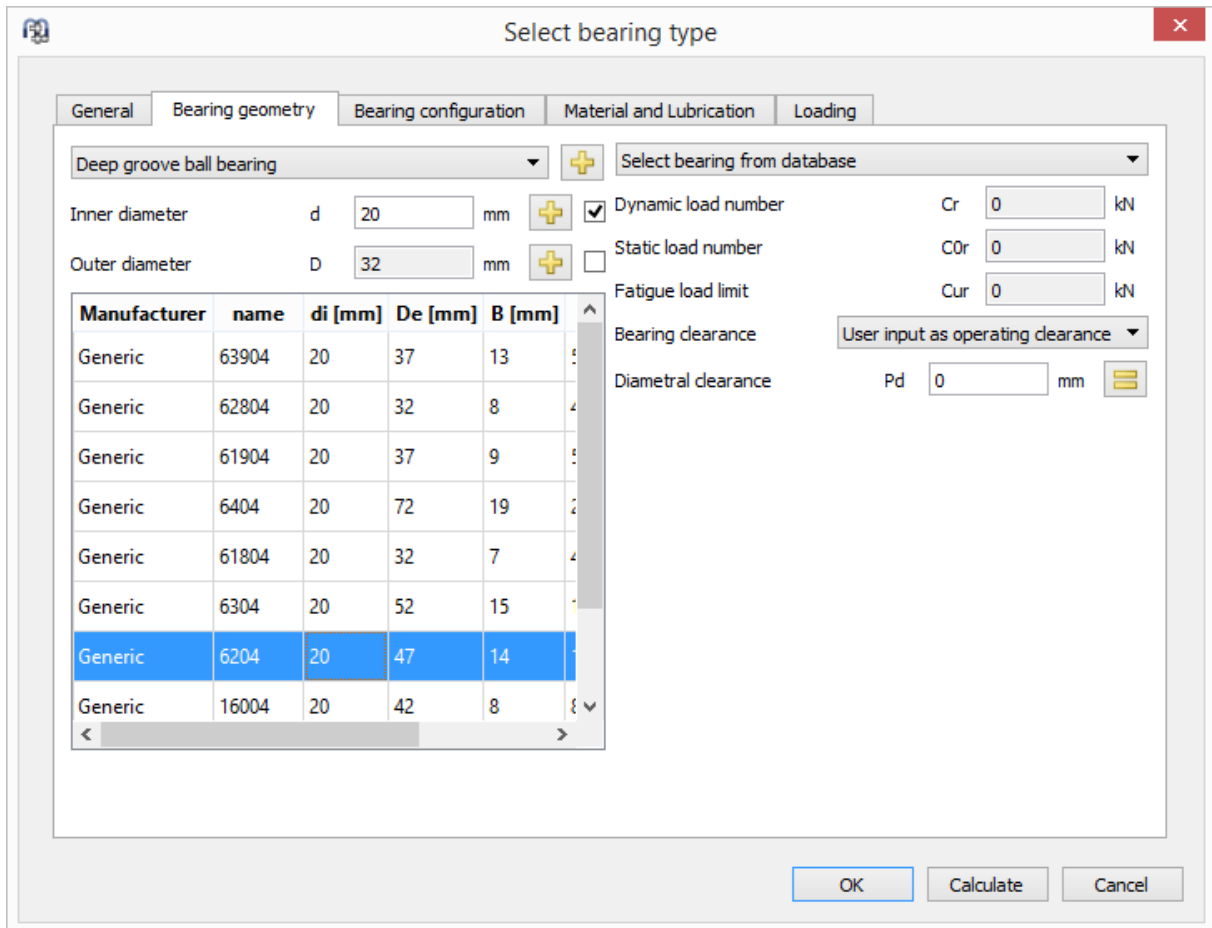

Radial cylindrical plain journal bearing

The load-displacement behavior of the plain bearing is calculated according to (ISO 7902-2, May 1998). Therefore, the ratio of width to diameter is restricted to $0.25 \leq B/D \leq 1.5$.

The parameters used for the definition of this bearing type are shown in the enclosed figure. Clearance represents the total diametric operating clearance between the journal and the bearing. Any eccentricity is introduced through the corresponding offset inputs in y and x direction.

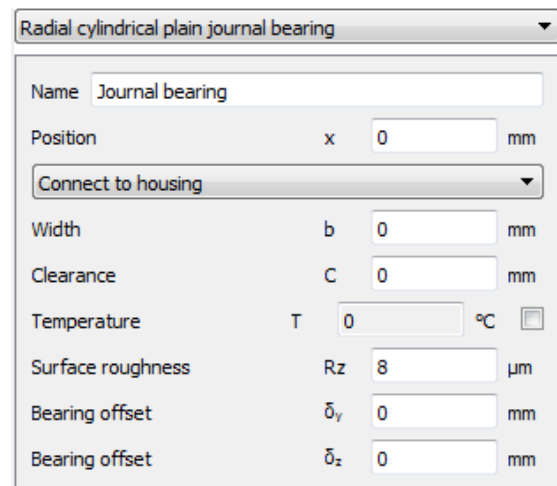

The optional temperature input does only affect lubricant viscosity. It does not affect clearance.

Surface roughness is the average between the shaft and the bearing and it is used to calculate a minimum required film thickness.

The outer ring of the bearing can be connected to either the housing or another shaft.

For modal analysis the unsymmetrical stiffness matrix of the plain bearing is replaced by two orthogonal springs, because of limitations of the FEA library. Therefore, any natural frequencies are an approximation only. No stability analysis can be performed with this software. Damping is not considered either.

Ball screw

A ball screw can be used as support element. The geometry of the ball screw can be defined at the ball screw element in the system tree. The button “define ball screw” is not yet active.

Coupling for reaction torque

A coupling for reaction torque fixes the rotation angle of a shaft. The sum of torques will be taken at this element.

Stiffness matrix

A general symmetric stiffness matrix can be defined between a shaft and the housing or between two shafts.

	ux [mm]	uy [mm]	uz [mm]	rx [mrad]	ry [mrad]	rz [mrad]
Fx [N]	0	0	0	0	0	0
Fy [N]		0	0	0	0	0
Fz [N]			0	0	0	0
Mx [Nm]				0	0	0
My [Nm]					0	0
Mz [Nm]						0

Damping matrix

A general damping matrix can be defined between a shaft and the housing or between two shafts.

	vx [m/s]	vy [m/s]	vz [m/s]	ωx [rad/s]	ωy [rad/s]	ωz [mrad/s]
Fx [N]	0	0	0	0	0	0
Fy [N]		500	0	0	0	0
Fz [N]			0	0	0	0
Mx [Nm]				0	0	0
My [Nm]					0	0
Mz [Nm]						0

Weld point

A weld point is fixing all six degrees of freedom. It is easier to use than a general constraint with all components set to ‘fixed’ but has the same functionality. The weld point can had the additional option to define a width. In case a width > 0 is defined, multiple weld points are considered automatically.

Planetary support

A planetary support is available for planetary shafts. The planetary shaft is always supported in radial and tangential direction by the carrier. The constraints in axial direction, against tilting or torsion can be activated independently.

Axial stiffness

The axial stiffness can be used to define a nonlinear spring in axial direction. An axial clearance can be used to define clearance or pretension, the data in the table has to start with (0, 0). If a diameter is defined, the axial stiffness will act as distributed stiffness on this diameter, therefore the support can also support tilting moments if loaded axially.

	u [mm]	F [N]
1	0	0
2	1	500
3	2	2000

The axial stiffness will be set to a very large value behind the last point for displacement in the table.

Cylindrical support

The cylindrical support allows to define a radial clearance over some widths and an axial clearance between two parts. It can be used to model a ring on or in a shaft. The constraint can be rigid or a stiffness can be defined. For the axial constraints a diameter can be defined so it also takes a moment load using a distributed axial stiffness.

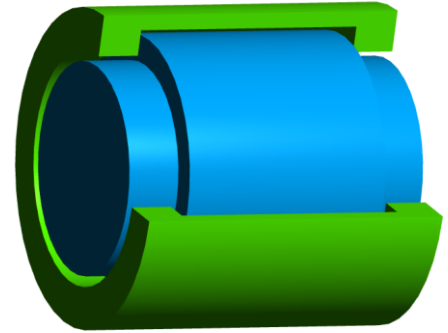

Cylindrical constraint

Name

Position x mm

Connect to housing

Width b mm

Diametral clearance Pd mm

Radial stiffness Cr N/mm

Consider temperature for radial clearance

Shaft is supported against torsion

Shaft is supported axially to the left

Axial clearance PaL mm

Diameter DL mm

Axial stiffness CaL N/mm

Shaft is supported axially to the right

Sections

Using “Sections” several cross sections can be defined for the strength calculation. One type of section is “Documentation point” which can be used without the module for strength calculation. In this case just displacements and forces are documented in the report, no strength calculation according DIN 743 is performed.

Dependent on the selected type of cross section several inputs are necessary to define details of the notch effect. All types from (DIN 743-2, Dezember 2012) are supported.

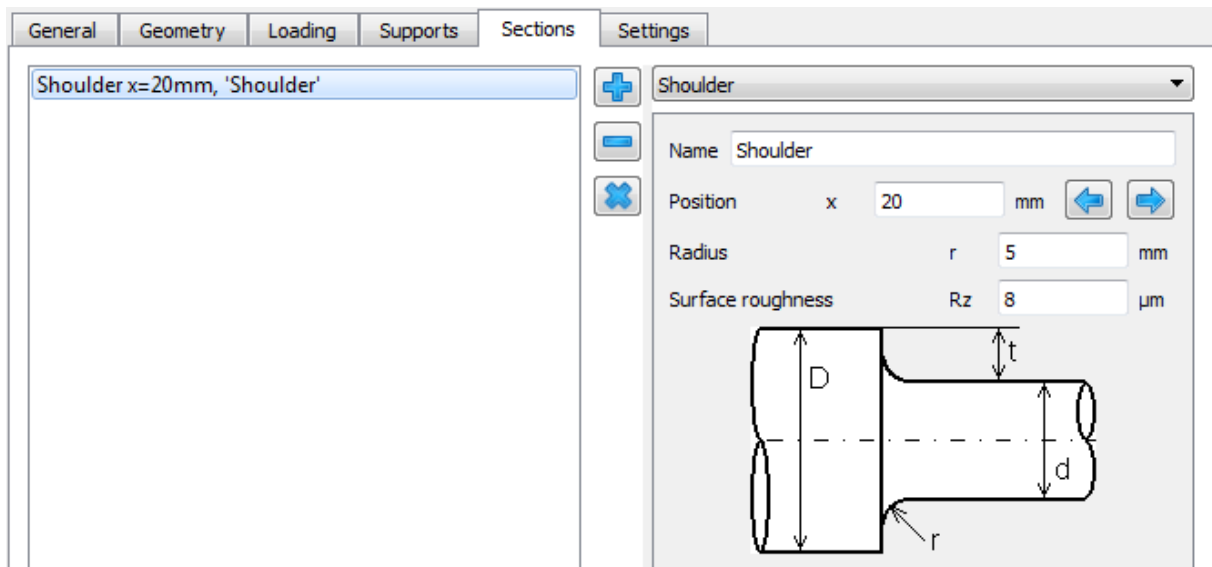

Settings

Some settings can be entered for a single shaft:

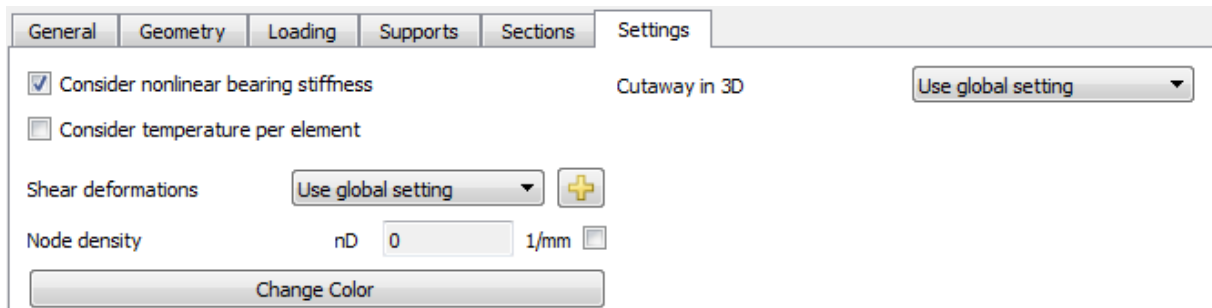

Consider nonlinear bearing stiffness

As default, the nonlinear bearing stiffness is considered for rolling bearings. For large systems this option can be cleared to decrease calculation time. Without this option, bearings are considered as rigid. The option is available for each shaft, so it can be set where bearing stiffness is important and can be cleared on other shafts.

If bearings with contact angle are used the nonlinear stiffness matrix should be considered to take into account the coupling of axial and radial loads.

Node density

The user can overwrite a node density for the FEA model. For a static linear calculation, the software adds additional nodes for improved resolution of diagrams. Results are only affected for conical

geometry not for cylindrical elements. For modal analysis the number of nodes can make a difference.

Reducing the node density decreases calculation time.

Change color

The color of the shaft can be changed. The transparency is only considered on 3D view, not in 2D view.

Consider temperature per element

By setting this flag the user can add a temperature difference ' ΔT ' (\pm) for each element created at the outer geometry on the temperature previously set at the tab-page 'General'.

Shear deformations

Here it is possible to define which shear coefficient value (κ) is being taken into account for the selected shaft. By default, the one defined at the global settings is used. The other approaches for the calculation of κ can be selected from the drop-down list. If 'user input for κ ' is selected, then the user has to press the -button in order to enter the desired value.

Cutaway in 3D

For each shaft the cutaway setting for the 3D view can be set independently of the general option selected under the tab-page 'Display settings'.

Options in system tree

The context menu with the right mouse button the system tree provides some additional options.

- "Delete" deletes the shaft
- "Duplicate" duplicates the shaft. This is helpful if several similar shafts are needed in a gearbox
- "Mirror" mirrors the shaft geometry and positions of forces and supports. The orientation of forces and supports is not changed.
- "Export deflection" exports a *.csv file for the deflection of a shaft. The "result tables" in menu report also contains this information, but for all shafts instead of one only.
- "Change color" allows to change the color of a shaft.
- "Import geometry" allows an input of shaft geometry as 2D DXF or 3D STEP, see below for details
- "Export geometry" exports the shaft as 3D STEP or IGES. Gears and bearings are included on the export.

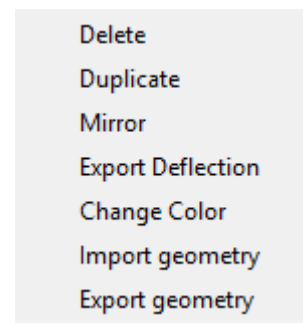

Import of shaft geometry from CAD files

The shaft geometry can be imported from 2D DXF or 3D STEP files. In case of a 3D-STEP file the x-axis has to be the axis of the shaft and it has to be only one part in the file. An intersection of the part in the x/y-plane is done and the resulting edges are considered as in the DXF input. Relief grooves in the CAD model can lead to many imported elements.

For the DXF file a normal drawing can be selected. Using the left mouse button some geometry can be selected. The selected geometry can either be deleted or it can be cut. This allows to select the

correct geometry for the import. The -button allows to switch through different layers within the DXF file.

If an inner geometry should be imported too, the flag at the bottom of the window has to be activated.

The DXF-file only contains lines. Sometimes the software cannot detect the correct connections between these lines. In this case the wrongly used lines can be selected and deleted. The lower part of the window shows the currently detected geometry input.

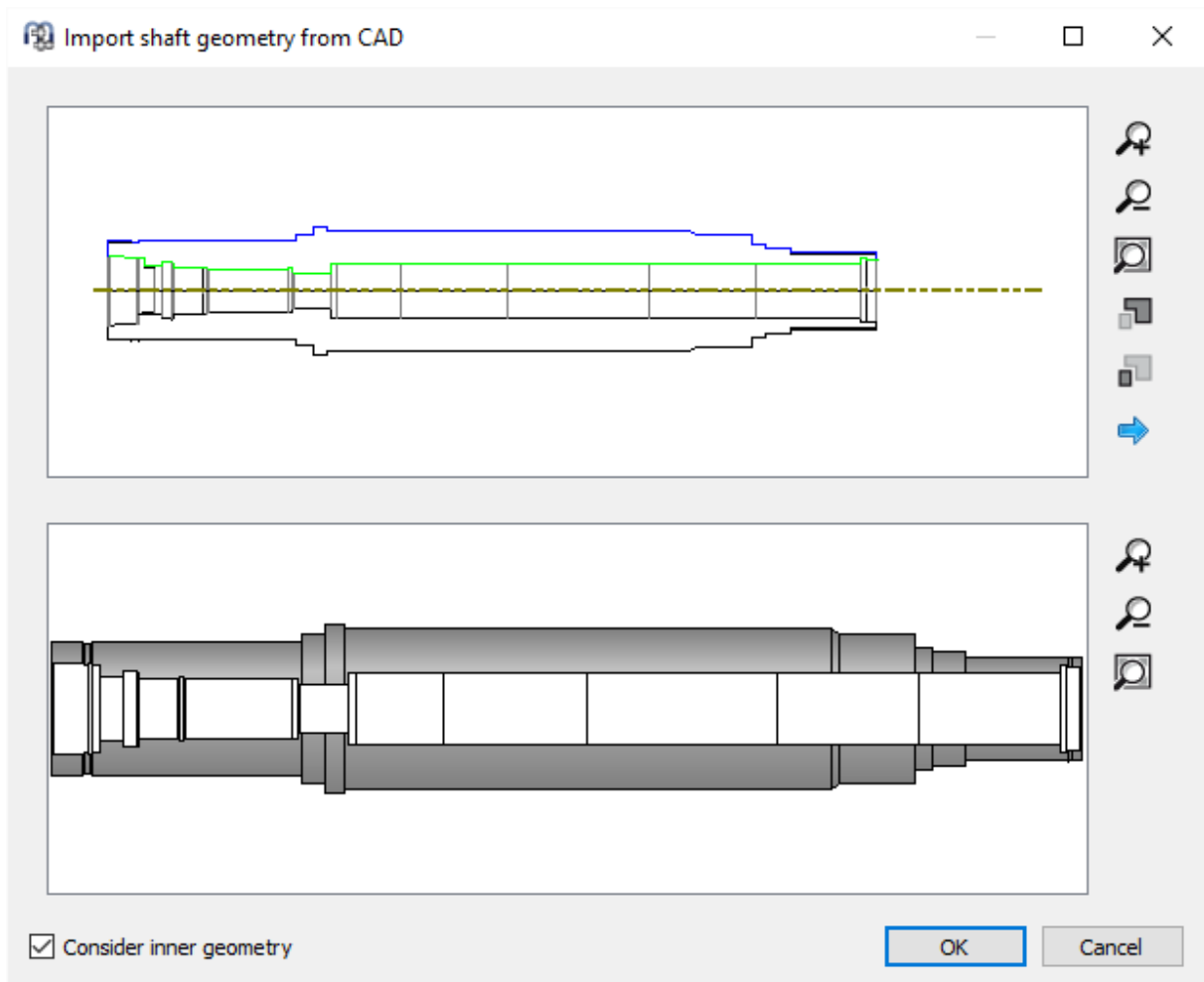

Shaft Groups

For systems with shafts that are not coaxial, shaft groups have to be added. For each group a position can be defined.

The positions can also be calculated by the software if constraints are used for positioning. See below.

Group name		Group 1	
Position			
X-Position	x	0	mm
Y-Position	y	0	mm
Z-Position	z	0	mm

There are three types of groups:

1. Standard group: The standard group can have an arbitrary position and it can hold subgroups. Shafts in different groups can not be connected by supports.
2. Coaxial group: The coaxial group can only be positioned axially relative to its parent group. Shafts in different coaxial groups can be connected by rolling bearings or other supports.
3. Planetary group: A planetary group is needed to define planetary gear sets. The number of planets can be defined in addition to position. Shafts in a planetary group rotate around a planet carrier. The centrifugal loads caused by this rotation are considered.

Positioning

If multiple groups are used an additional entry for positioning is shown in the system tree.

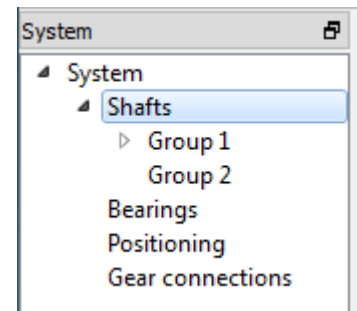

The page “Positioning” can be used to define constraints for group positions. New constraints are added using the -button, they can be sorted using the arrows. The constraints are evaluated once per calculation, so the order can be important.

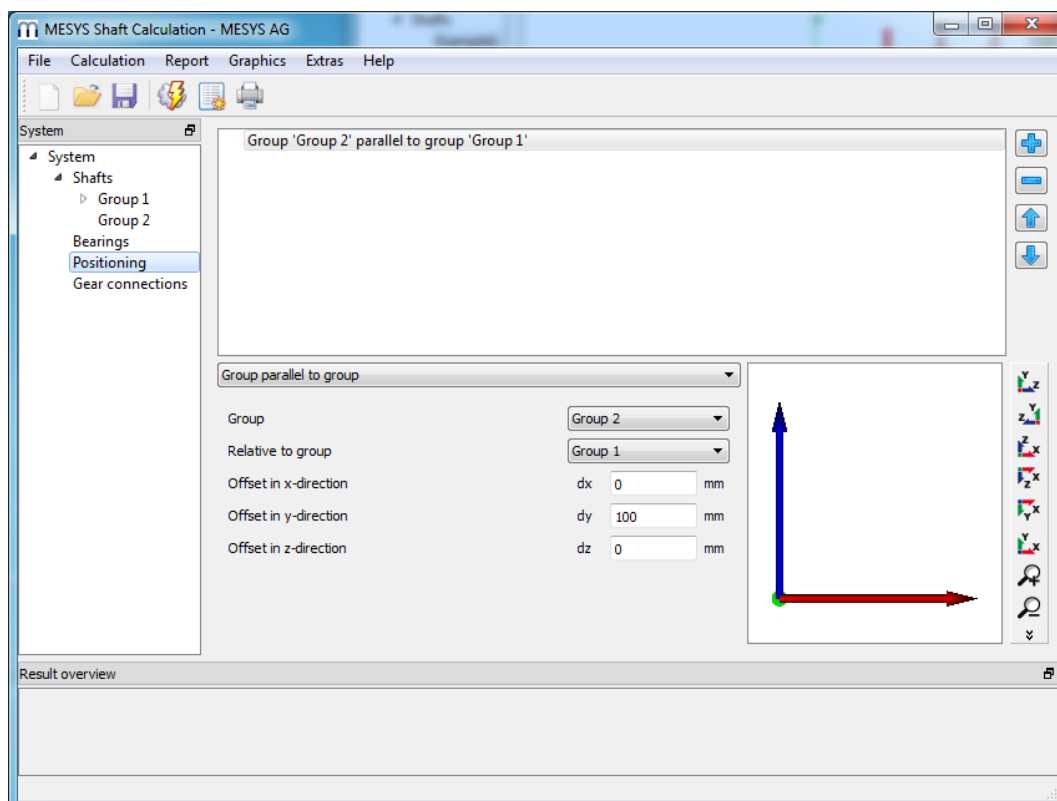

Different constraints are available:

- Group parallel to group: Specify an offset between two groups.
- Group according to gear pair: The selected group is positioned according to the selected gear pair. An additional angle has to be specified, zero is for a center distance on the y-axis. An axial offset can be entered if the centers of the gears should not align axially.
- Group according to two gear pairs: One group is positioned according to the center distances of two gear pairs. The axial position is defined by the first gear pair.
- Group according bevel gear pair: One group is positioned according to geometry data of a bevel gear. The angle of contact for the reference group can be defined.
- Shaft according to gear pair: This constraint is moving a shaft axially so that the centers of the gears are aligned. An axial offset can be entered optionally.
- Gear according to gear pair: This constraint is moving a gear axially so that it is aligned with its mating gear. Here an axial offset can be entered optionally, too.
- Group according worm gear pair: The selected group is positioned according to the selected worm gear pair. An additional angle has to be specified, zero is for a center distance on the y-axis. An offset can be entered axially to the worm.

Gear connections

If multiple groups are defined a page for gear connections is shown. Gear connections can be added using the -button. The shafts and gears in contact can be defined and the basic data for the gear pair is shown. The data for the gears can be modified in this window in addition to the inputs at the single shaft but using the connection allows to change data for both gears at the same time.

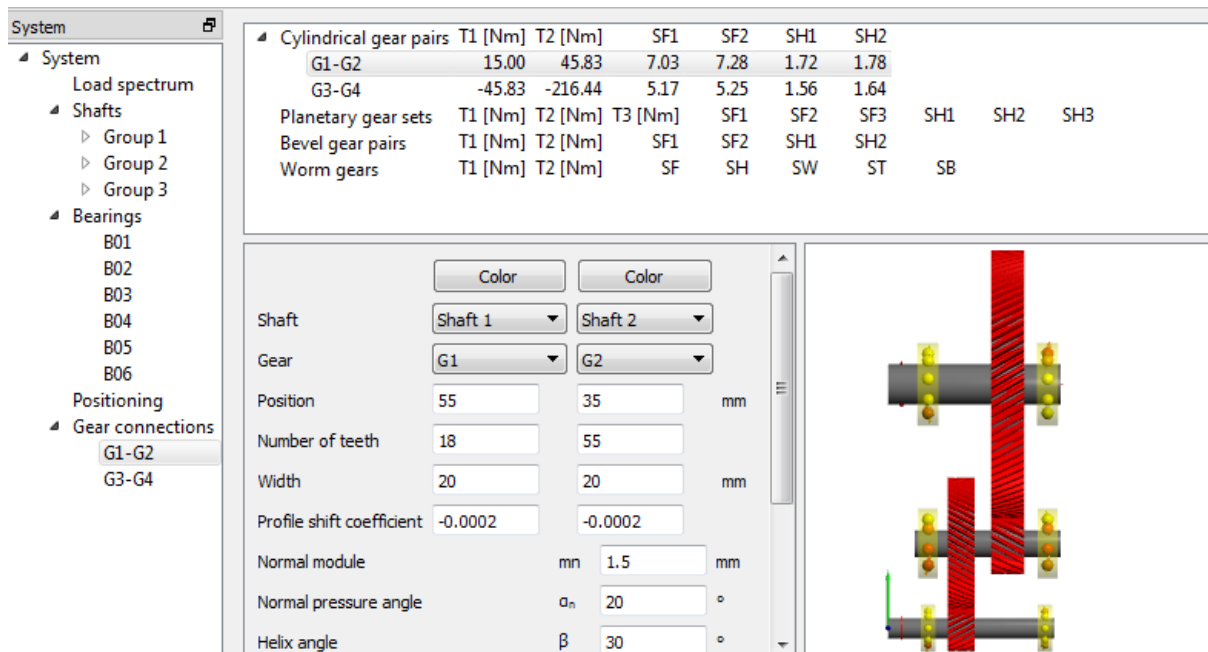

Cylindrical gear pairs		T1 [Nm]	T2 [Nm]	SF1	SF2	SH1	SH2
G1-G2		15.00	45.83	7.03	7.28	1.72	1.78
G3-G4		-45.83	-216.44	5.17	5.25	1.56	1.64

Planetary gear sets		T1 [Nm]	T2 [Nm]	T3 [Nm]	SF1	SF2	SF3	SH1	SH2	SH3
Bevel gear pairs		T1 [Nm]	T2 [Nm]	SF1	SF2	SH1	SH2			
Worm gears		T1 [Nm]	T2 [Nm]	SF	SH	SW	ST	SB		

Shaft	Shaft 1	Shaft 2	
Gear	G1	G2	
Position	55	35	mm
Number of teeth	18	55	
Width	20	20	mm
Profile shift coefficient	-0.0002	-0.0002	
Normal module	mn	1.5	mm
Normal pressure angle	α_n	20	°
Helix angle	β	30	°

The torque on each gear pair is shown in the list at the top; the safety factors are shown if a connection to a gear calculation program is set up.

With a click on the items for the gear pairs in the system tree on the left the gear calculation program can be started to define details for the gear pair. The shaft calculation is passing basic gear geometry (z , b , x , m_n , α_n , β , x , a) to the gear calculation and loading; it is reading back the same geometry data

and the safety factors. The colors of the gears can be changed by clicking on the “Color”-button shown in the picture.

If a gear is considered in a connection, its torque input is hidden at the corresponding input window under the page ‘Loading’.

Tooth flank modification

With the goal of ensuring optimum tooth flank contact, the teeth of gear pairs can undergo flank corrections based on three different approaches according to the standard (ISO 21771:2007, September 2007), i.e. Flank line crowning, Flank line slope modification and Flank line end relief. By pressing on ‘Tooth flank modifications’ at the page ‘Gear connections’ a pop-up window allows the user to enter the corresponding geometrical data in relation with these approaches. For each gear it is possible to have either symmetric or unsymmetrical modifications by setting or clearing the available flags respectively at the bottom. By activation of an unsymmetrical flank modification, the corresponding data column is added in the window.

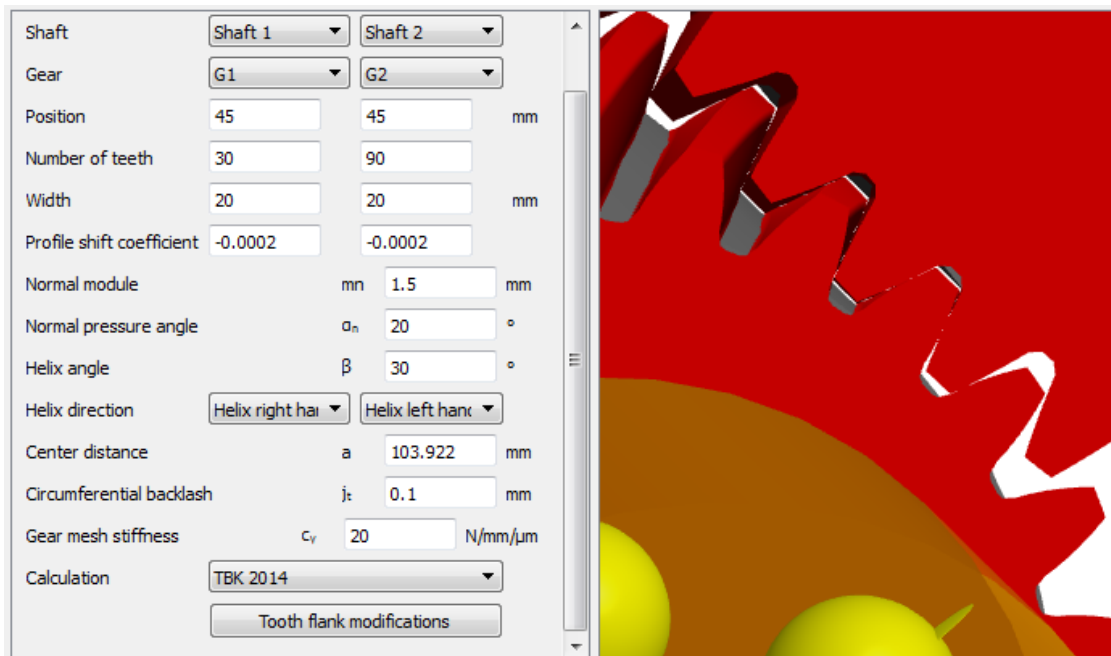

Tooth flank modifications

	Gear 1 right flank [mm]	Gear 1 left flank [mm]	Gear 2 right flank [mm]	Gear 2 left flank [mm]
Flank line crowning $C\beta$	0	0	0	0
Flank line slope modification $CH\beta$	0	0	0	0
Flank line end relief amount I $C\beta I$	0	0	0	0
Flank line end relief length I $L C I$	0	0	0	0
Flank line end relief amount II $C\beta II$	0	0	0	0
Flank line end relief length II $L C II$	0	0	0	0

Symmetric modifications for gear 1
 Symmetric modifications for gear 2

OK Cancel

Flank line crowning

It consists of a relief based on a circular arc which is tangent to the mid-point of the tooth width. The relief amount, which is measured from the end of the tooth, must be specified.

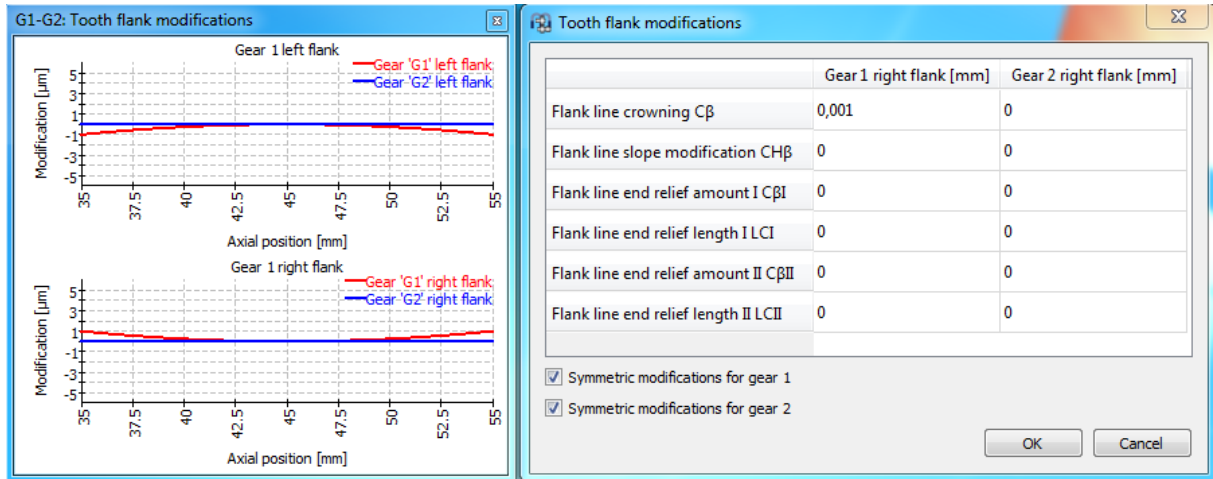
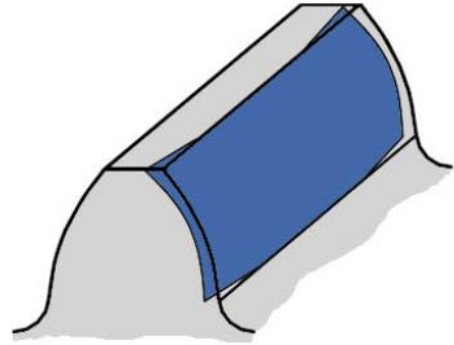

Flank line slope modification

It consists of an increasing linear relief over the whole tooth width. So the slope of the relief line starting from one end to the other must be specified.

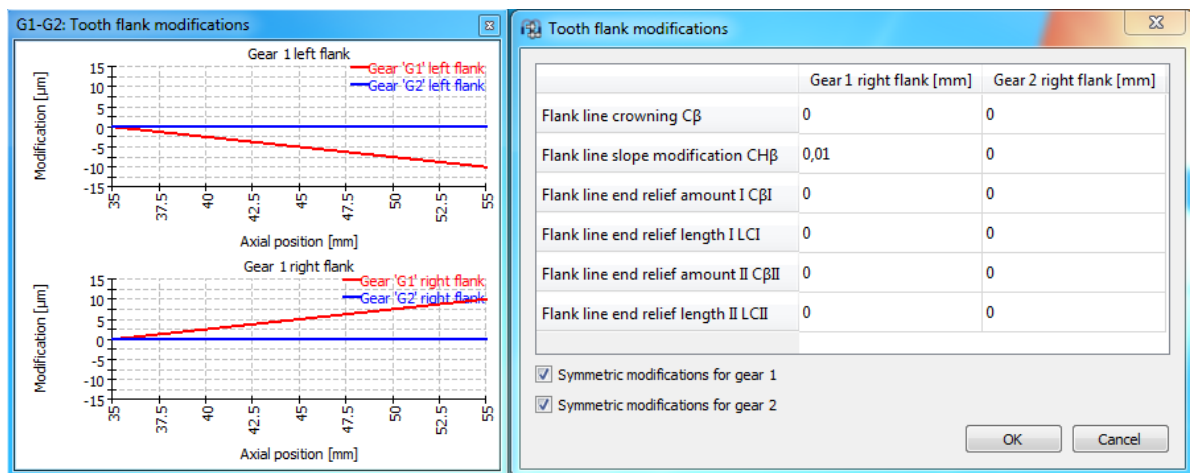
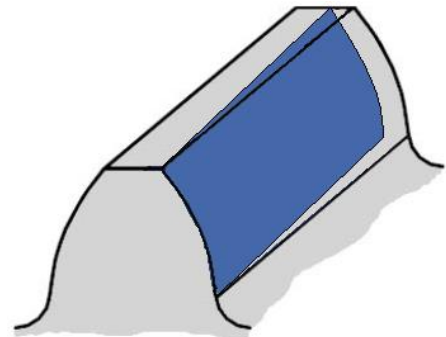

Flank line end relief

It consists of an increasing linear relief starting from a certain point until the end of the flank line. The relief amount and length, which are measured from both ends of the tooth, must be specified.

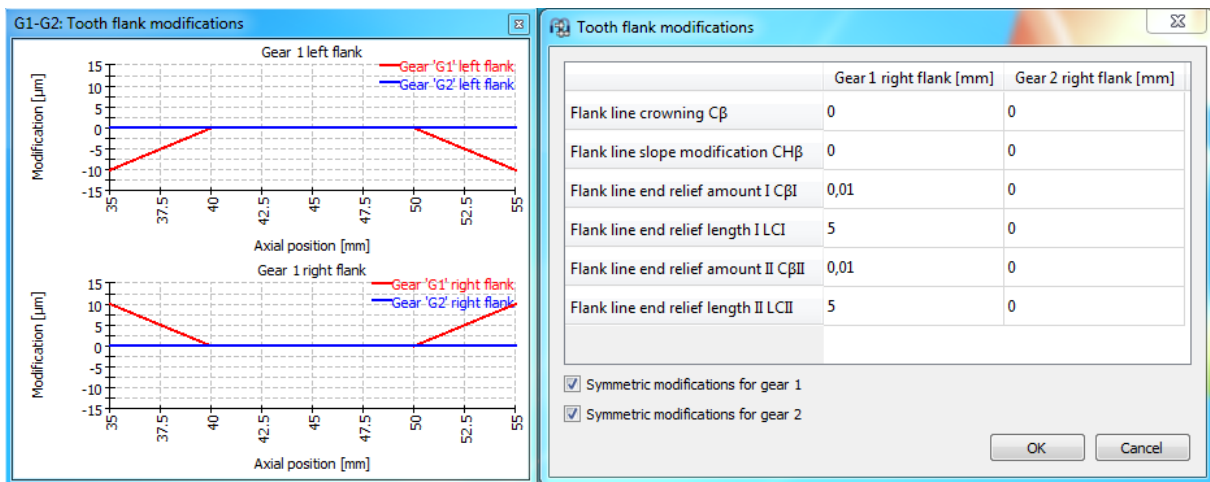
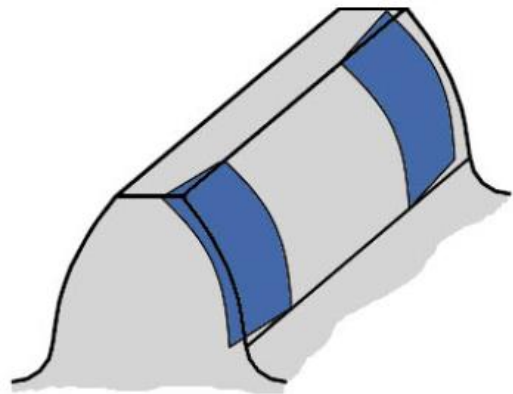

All in all, the user can make use of the line load and gap width graphics as guidance to establish a flank correction proposal. If, for instance we start from a gear tooth mesh condition like this:

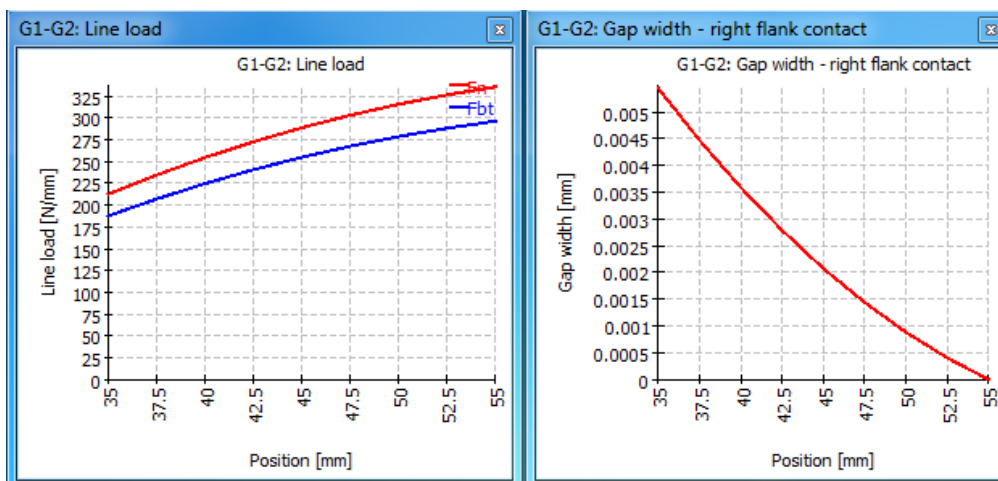

And we apply a combination of Flank line crowning and Flank line slope modification, it significantly helps to have an homogenous Line load as shown in the following pictures:

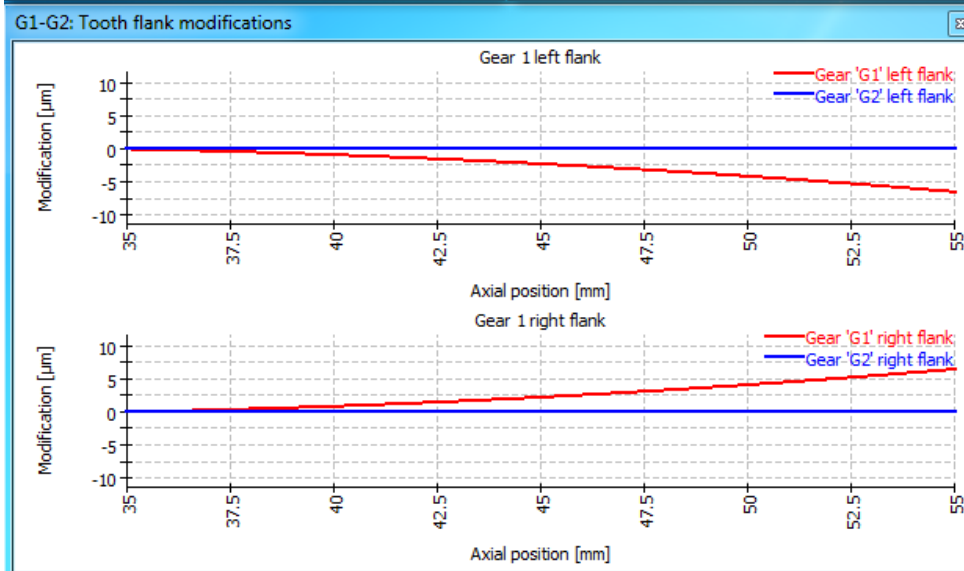
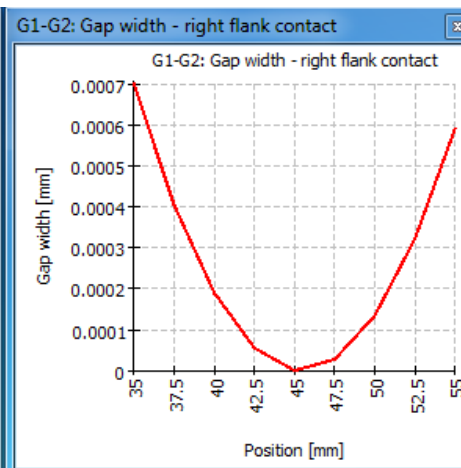
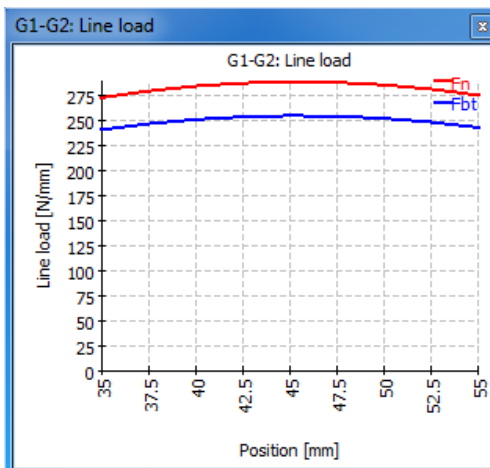
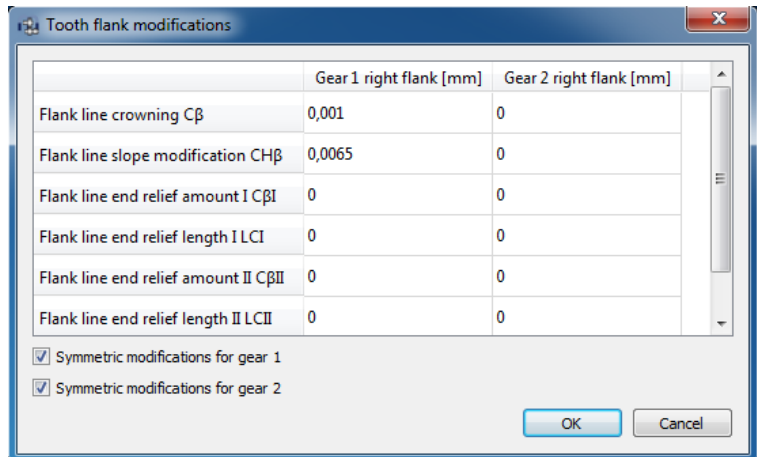

Calculation with load spectrum

If the flag for the calculation with load spectrum is set on the 'System'-page, an additional item titled load spectrum is shown in the system tree.

The screenshot shows a software interface with a system tree on the left and a table in the center. The system tree includes 'System', 'Load spectr...', 'Shafts', 'Shaft 1', 'Shaft 2', 'Bearings', and 'Bearing'. The table has the following data:

	Frequency	n [rpm]	Fy [N]	My [Nm]
Shaft		Shaft 1	Shaft 1	Shaft 2
Element		General	Load	Load
1	0,6	1500	250	-80
2	0,3	1200	150	-60
3	0,1	600	100	-30

A context menu is open over the table, showing 'General', 'Shaft 1', 'Shaft 2', and 'Hide All'. The 'Shaft 2' menu is further expanded to show 'General' and 'Load', with 'Load' selected and a sub-menu showing 'T' and 'n'.

By default, the table is empty. Only the column header for the load frequency is shown. By right clicking somewhere on the window, different calculation parameters for the load cases can be added optionally as column headers. These parameters are classified as "General" and "Load". Concerning the rows in the table, they can be added using the -button and also deleted by selecting it and using the -button. These rows are called "Element" and are taken into account as a load case where the values (inputs) corresponding to the calculation parameters can be entered. The -button clears all the inputs of the table, also the elements (rows).

You can hide any header by right clicking on it and selecting "Hide". For all load components that are not shown in the table the default value is used.

Using the -button the load spectrum is read from a file. The columns in the file have to be in the same order and unit as shown in the table. Likewise, a created load spectrum table can be exported with the corresponding -button.

The default graphics for deflection are shown for the selected "Result element". Natural frequencies are also calculated for this "Result element".

Running calculation for one load spectrum element only

It is possible to run the calculation for only one element (load case), if the user sets the flag 'Run calculation for result element only'. The desired load case is chosen by either using the arrows of the small box next to the -button or typing the element number into it directly. The graphics will be only shown for the selected element.

This allows using the load spectrum calculation as input interface for independent load cases, which are calculated independently.

Configurations

Configurations can be activated on the first input page for settings, if multiple groups are defined.

	Name	G1a-G1b	G2a-G2b	G3a-G3b	G4a-G4b	GRa-GRb	GRb-
1	G1	<input checked="" type="checkbox"/>	<input type="checkbox"/>	<input type="checkbox"/>	<input type="checkbox"/>	<input type="checkbox"/>	<input type="checkbox"/>
2	G2	<input type="checkbox"/>	<input checked="" type="checkbox"/>	<input type="checkbox"/>	<input type="checkbox"/>	<input type="checkbox"/>	<input type="checkbox"/>
3	G3	<input type="checkbox"/>	<input type="checkbox"/>	<input checked="" type="checkbox"/>	<input type="checkbox"/>	<input type="checkbox"/>	<input type="checkbox"/>
4	G4	<input type="checkbox"/>	<input type="checkbox"/>	<input type="checkbox"/>	<input checked="" type="checkbox"/>	<input type="checkbox"/>	<input type="checkbox"/>
5	GR	<input type="checkbox"/>	<input type="checkbox"/>	<input type="checkbox"/>	<input type="checkbox"/>	<input checked="" type="checkbox"/>	<input checked="" type="checkbox"/>

Using the right mouse button additional columns can be added to the view. Available are gear connections, reaction couplings and general constraints.



Rows can be added using the -button and with the check box the active elements for each configuration can be selected. Clearing the flag only disables the torsional constraint of general constraints, constraints in all other directions are not affected.

The active configuration can be selected at the bottom of the window or within a load spectrum.

Housing stiffness matrix

A symmetric stiffness matrix can be defined between the supports (only those which are connected to the housing) and the housing, thus acting as boundary condition at its connecting point. This enables the user to simulate different ways of stiffness interaction, also between the bearings or supports by means of the housing.

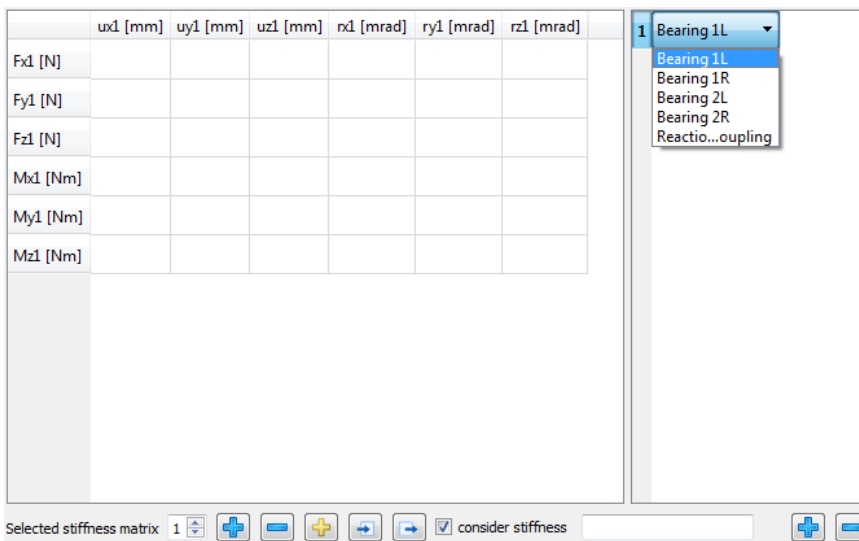
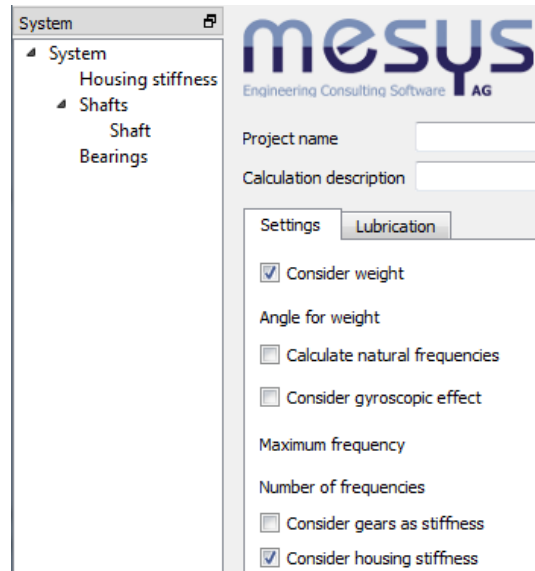

In order to make use of this option, the corresponding flag of 'Consider housing stiffness' must be activated at the tab-page 'Settings' which it is shown when selecting 'System' from the software tree.

The -button, located under the matrix, can be used to create any additional type of stiffness matrix, which is referenced with a number shown in a box titled 'Selected stiffness matrix'. Any one or all of these created matrices can be excluded for the calculation at any time by using the flag titled 'consider stiffness'. In this way, any matrix data can be kept, even though it is not being used for the analysis. In case we do want to erase any of the matrices, the -button can be employed for it. The entry field can be used to name them and their names will be shown in the report.



By clicking once the -button on the right lower corner, a new numbered element is listed on the window above it and a matrix is shown on a bigger window. With a double click on this element a drop-down list is released letting us choose the support to consider. By repeating this procedure, we could add other existing bearings or supports on the list, and therefore their corresponding lines and columns of the stiffness matrix would be shown and taken into account.

	ux1 [mm]	uy1 [mm]	uz1 [mm]	ux2 [mm]	uy2 [mm]	uz2 [mm]	
Fx1 [N]	2e+11	0	0	0	0	0	1 Bearing 1L
Fy1 [N]		2e+11	0	0	0	0	2 Bearing 1R
Fz1 [N]			2e+11	0	0	0	
Fx2 [N]				1.5e+11	0	0	
Fy2 [N]					1.5e+11	0	
Fz2 [N]						1.5e+11	

All the values for the stiffness can be entered manually with double click on the cells or also be loaded as a matrix, which is sometimes obtainable from a finite element analysis, by using the import button . Equally, a created matrix can be exported with the corresponding export button .

If we use the -button, a pop-up window allows activating four additional options. As shown in the following picture, we can for instance omit the consideration of rotation stiffness, and activate the possibility to define for the connecting point, in any available direction required, a force or a moment with 'Enter force/moment', and also a certain displacement or rotation with 'Enter displacement'.

	ux1 [mm]	uy1 [mm]	uz1 [mm]	F/Mext
Fx1 [N]	2e+11	0	0	0
Fy1 [N]		2e+11	0	0
Fz1 [N]			2e+11	0
du/dr	0	0	0	

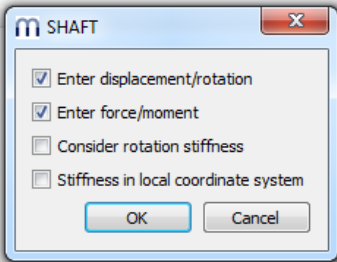

The usage of the last option which let us to consider the stiffness from the local coordinate system of the connecting point.

3D elastic parts

The context menu under “Shafts” or under groups allows to insert “3D elastic parts as shaft” or “3D elastic parts as housing”. A new part will then be shown in the shaft/group tree.

The 3D elastic parts combine the FEA beam model used for the usual shafts with 3D solid meshes. The stiffness of the 3D solids is reduced to a stiffness matrix, which is then considered in the solver for the beam model. On the first use of the 3D-elastic part the reduced stiffness matrix is generated, which can take a while dependent on the size of the mesh. Afterwards the reduced stiffness is saved with the file and only needs to be regenerated in material, mesh or selections for faces are changed.

The 3D elastic parts as housing are considered as stiffness and optionally by modal reduction. 3D-elastic parts as shaft are currently only considered as stiffness. No mass is taken into account. Thermal expansion and weight are considered. In case of a calculation of natural frequencies only the stiffness of the 3D elastic parts as shaft is considered, no masses.

If the option “calculate displacements” for the 3D-elastic parts is selected, the displacement field of the surface is calculated for each connected degree of freedom on initial calculation of reduced stiffness. This increases the initial calculation and the file size, but allows to visualize the deformed shape afterwards. The same is valid for the option “calculate mode shapes” for 3D-elastic housings; this is used for visualization only too.

3D elastic part as shaft

A 3D elastic part as shaft is a rotating part with one axis which can be connected to other shafts. Currently axisymmetric parts defined by a polygon or a STEP-import can be considered.

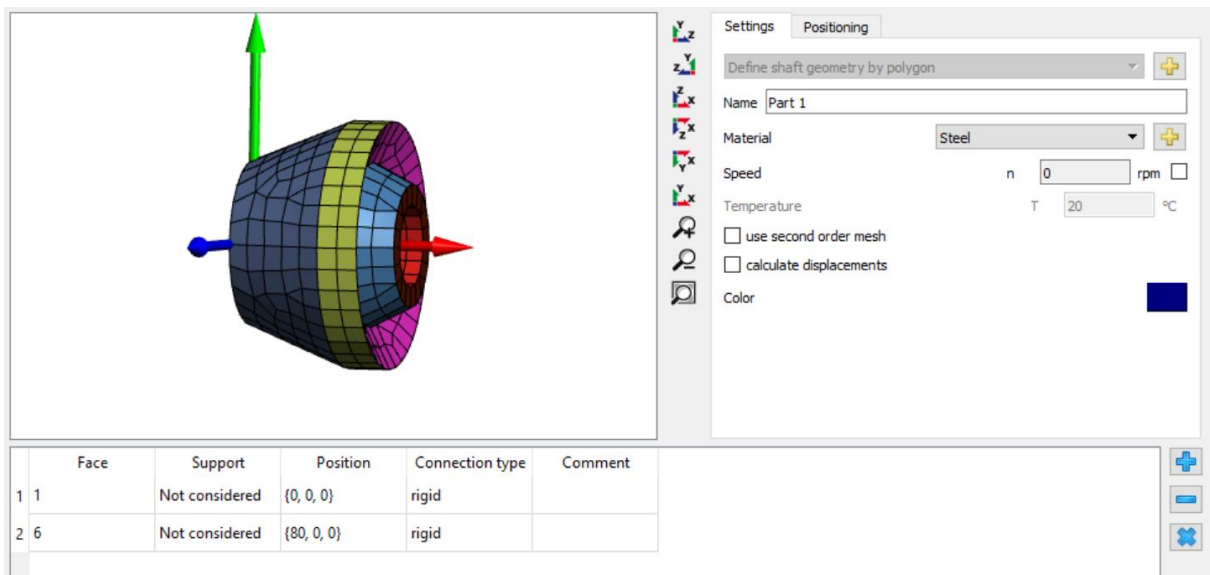

Using the **+**-button behind “Define shaft geometry by polygon” a dialog opens to define the geometry using a polygon. It should be defined clockwise. “x” is the axial coordinate, “y” the radius. Optional connections to normal shafts can be defined as “Considered as face” or “Considered as edge”. Either all points on a face or only points on an edge will be connected to a shaft support element.

In addition, the mesh size can be defined in this dialog.

Additional settings are the material, the rotation speed, the option to select a second order (quadratic) mesh and the option if the displacements should be calculated. Using a quadratic mesh is recommended for better accuracy. The calculation of displacements increases the calculation time and would only improve the deformed shape in the 3D view. Thermal expansion is not yet considered, therefore the input of temperature is deactivated.

Under “Positioning” the axial position can be defined.

In the table of the main view the support elements of the shafts have to be selected under “Support”. The connection type “rigid” enforces a rigid connection of the selected face/edge to the beam node of the shaft. The connection type “average” enforces an averaged connection to the node, which leads to less stiffening of the 3D elastic part.

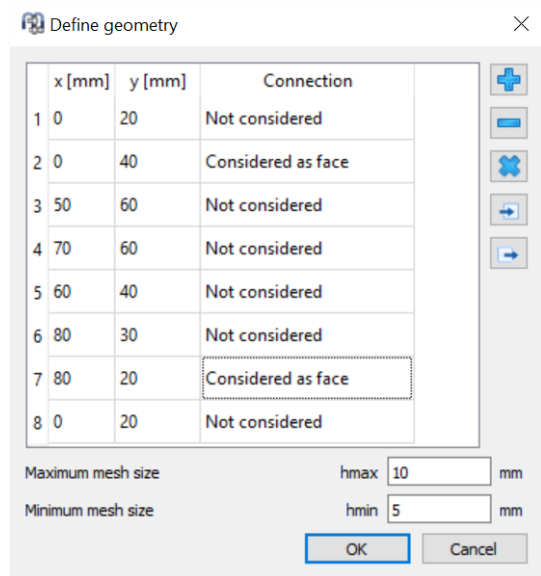

3D elastic planet carriers

In case of a 3D elastic shaft also planet carriers can be defined. Either imported as STEP-file or as parametric planet carrier. For a parametric planet carriers, the following basic shapes are available:

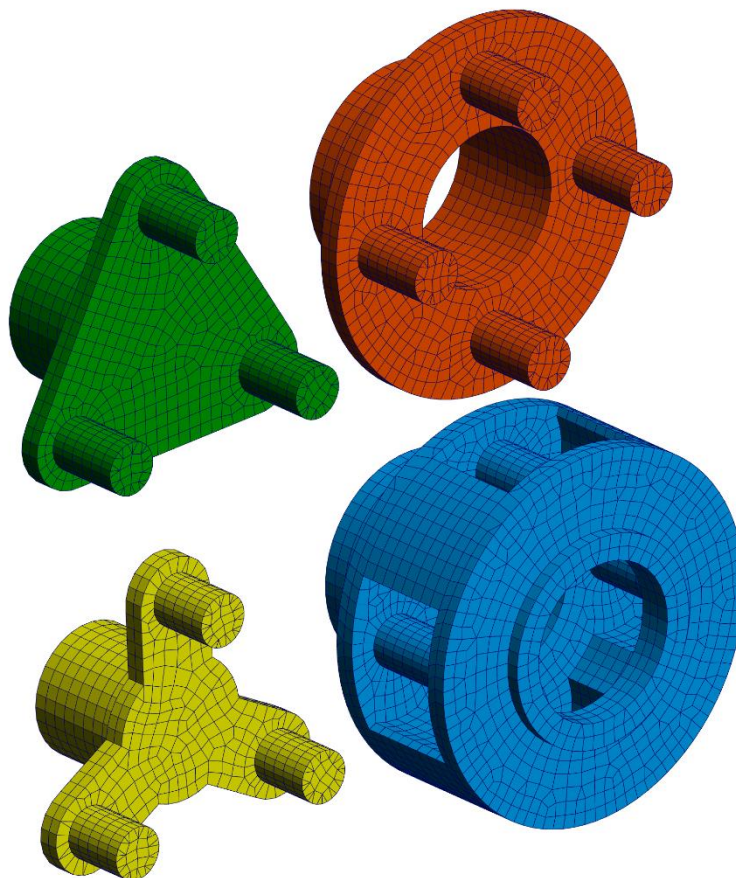

For an imported planet carrier, the rotation axis has to be the x-axis.

3D elastic part as housing

A 3D elastic part as housing can be connected to shafts in different groups, it does not rotate and at least one face has to be set as fixed. Currently it can only be imported from CAD geometry as STEP-file or as Nastran mesh.

Face	Support	Position	Connection type	Comment
1 6	Set as fixed	{0.00141155, 0.000495987, -2.5}	rigid	Set bottom face as fixed
2 38	Not considered	{-39.9998, -33.5, 59.9998}	rigid	
3 39	Not considered	{-40.0005, 33.5, 60.0003}	rigid	
4 40	Not considered	{20.0015, -33.5, 60}	rigid	
5 41	Not considered	{20.0021, 33.5, 59.9993}	rigid	

Using the **+**-button behind “Import CAD geometry” a STEP-file can be selected. An assembly with connected parts is glued together automatically. Afterwards the required mesh size can be entered. Alternatively, a Nastran mesh can be imported; only the surface mesh is kept in this case.

In the 3D view for the parts now multiple faces can be selected by mouse double click on a face. The faces can then be connected to a shaft support element or “Set as fixed”. As above a rigid connection or an averaged connection can be selected. To merge two connected faces, select both faces in the table, press the right mouse button and select “Merge faces”.

Under settings as before the material and options for a second order (quadratic) mesh and for calculation of the displacements can be selected. In addition, a 3D-elastic housing can be supported in modal analysis; if “calculate mode shapes” is selected, the mode shapes can be shown too. Under “Positioning” the position and rotation of the 3D part can be defined.

The selected support element will be connected to the nodes of the selected faces. A rigid or averaged connection will be considered, no contact and no clearance will be considered.

Parameter variations

Using the menu point “Calculation”->”Parameter variation” a dialog for parameter variations is shown. It allows the user to do parameter studies with results provided in tables and graphics.

Typical applications are, for example, visualizing life over clearance or displacement over load.

Generate list

Several input parameters can be added to the table rows at the tab window “Generate list”, and ranges (Start/End values) can be defined for them as shown in the picture below.

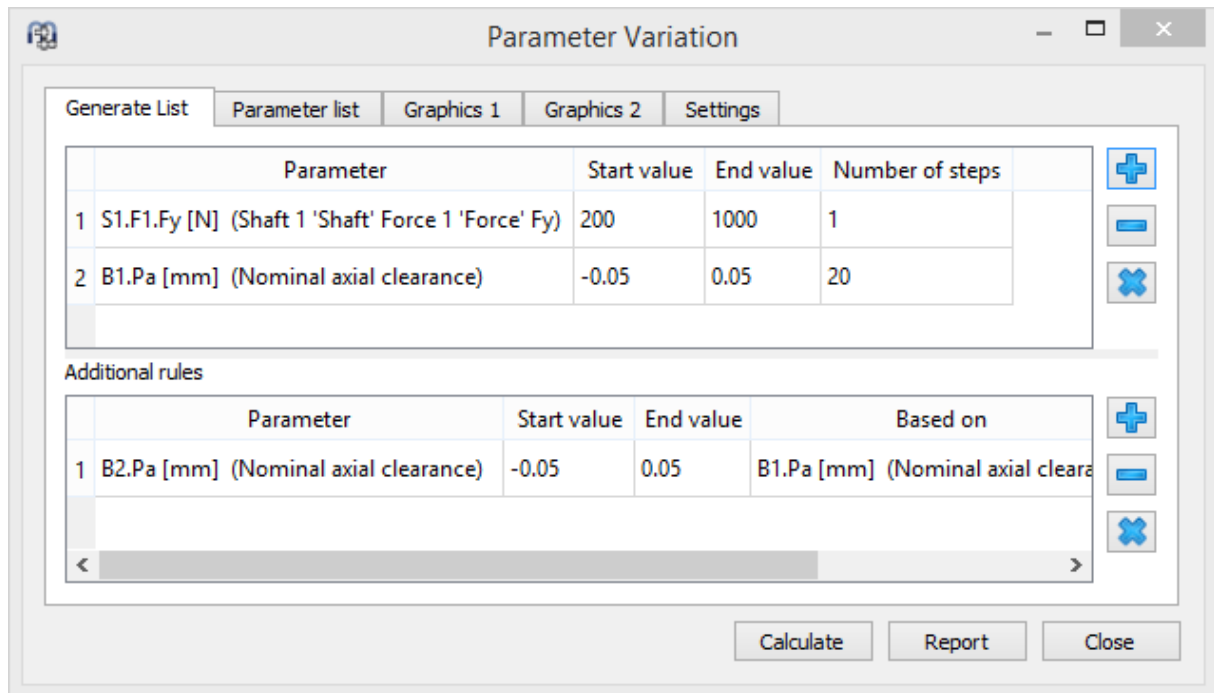

Additional rules can be used to set additional input parameters dependent on parameters on the first list. The additional parameter is interpolated between a start and end value based on another parameter. For example, additional parameter y between y1 and y2 based on parameter x in range x1 to x2:

$$y = y_1 + \frac{y_2 - y_1}{x_2 - x_1}(x - x_1)$$

In above screenshot the clearance of both bearings is set to the same value.

Parameter list

Before we generate a list, it is necessary to define first those outputs or variables we are interested in at the tab window ‘Parameter list’.

As shown in the picture, by doing a right mouse-click on the tab window ‘Parameter list’, a context menu will enable us to add the columns corresponding to the outputs or results we are interested in. The rows will contain the variable values according to the bounds and number of steps.

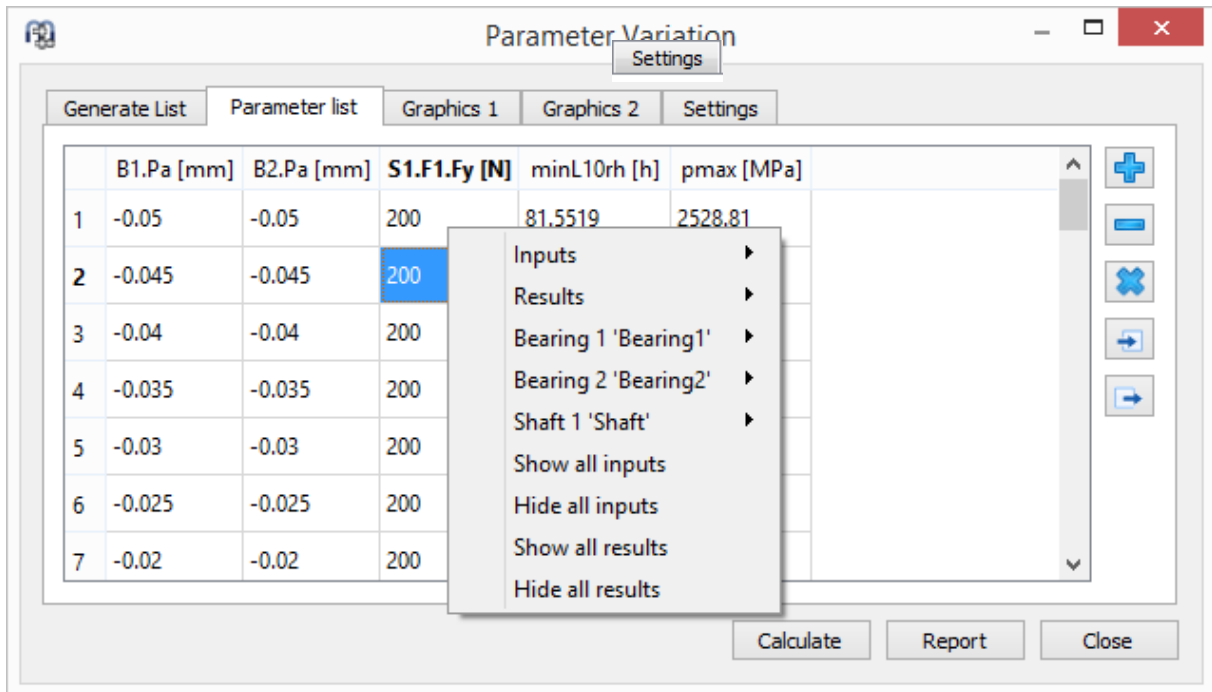



By clicking on 'Calculate' while the "Generate list" tab window is active, a list of all parameter combinations will be generated at the corresponding tab window 'Parameter list' and the analysis will be run. Depending on the chosen number of parameters and steps, the analysis can lead to long calculation times.

A second way to create a table (parameter list) is possible by adding rows and entering values manually with the -button. Moreover, a whole table can be imported from a csv-file using the -button or exported into a file using the -button. Then, in order to run the analysis, we just have to click on "Calculate" while this page is active. Please note that the any parameter list is not saved if the dialog is closed.

Graphics

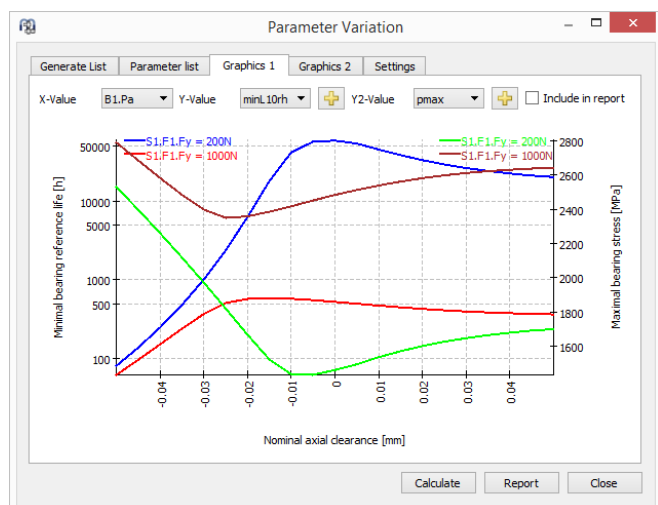
On the pages "Graphics1" and "Graphics2" the results can be shown as graphics. If the parameter list was generated by "Generate list" and no more than two input parameters are used, lines are used for the diagram (for more than two input parameters or other sources just points are shown). The graphic area consists of two different y-axis, thus being possible to compare different types of output results (units) at a time. As shown in the picture at the top right, we can see that the axial clearance that optimizes the life varies depending on the moment load, but also which axial clearance brings down the contact pressure, pmax, to a minimum value.



Moreover, the line charts of the chosen outputs can be overlapped so that the user can easily perform any comparisons. This is shown in the picture on the bottom right: Although the basic life (L10h) is being primarily analyzed in the graphic, by doing a click on any of the -buttons, it could also be possible to add any other analyzed outputs with the same units of one of the two available y-axis.

Report

You have to activate the checkbox 'Include in report' if the graphic should be added to the report. Moreover, under the last tab-page 'Settings' another checkbox is available for including the parameter list in the report.

Statistical parameter variations

Using the menu point "Calculation" -> "Parameter variation (statistical)" an analogous tool to the default parameter variation is available. The main difference between them lies in the fact that this tool supports statistical evaluations when doing parameter variations.

The default version of parameter variation is helpful to visualize the influence of one parameter on one or multiple results. The statistical version can be used if the influence of multiple uncertainties should be evaluated. Instead of manually checking multiple parameters an automatic calculation of the whole ranges can be done. In order to understand the reasons behind the results it will still be necessary to carry out additional evaluations, but the software shows the ranges of results that have to be expected.

Generate list

As in the normal parameter variation, several input parameters can be added to the table "Generate list" and ranges (Start/End values) can be defined for them. No calculations steps are required for the ranges. However, a limitation on the number of statistical calculations can be set under the tab-page 'Settings'. A first insight is already possible with a smaller number of calculations, but for nice-looking curves several thousand calculations are needed.

Different types of probability distributions can be chosen from a drop-down list which is shown when double-clicking on a cell under the 'Distribution' column for any of the parameters:

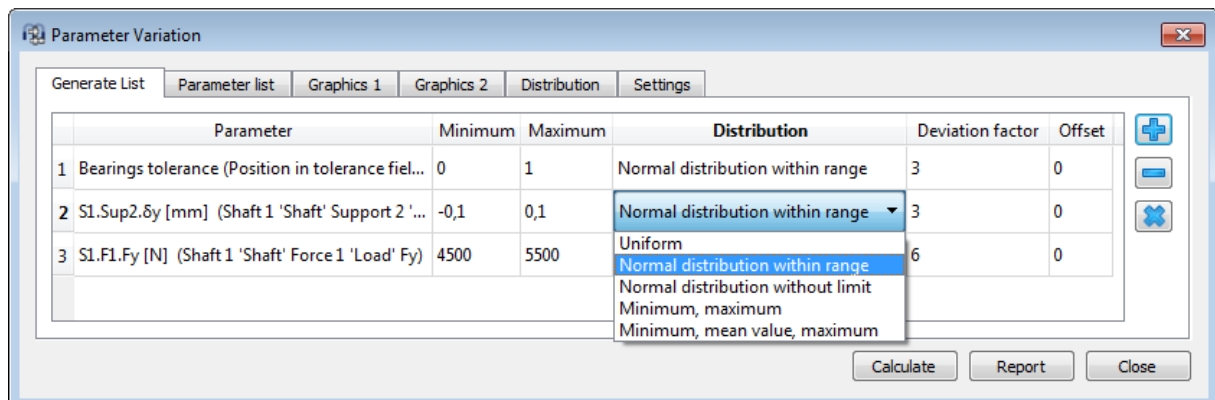

- Uniform: The probability is equally distributed for a set of values between the maximum and minimum value of the parameter.

- Normal distribution within range: The probability is calculated for a set of values ranging from the minimum to maximum by using a normal distribution.
- Normal distribution without limit: The probability is calculated for a set of values theoretically in the range of $(-\infty, +\infty)$ by using a normal distribution.
- Minimum, maximum: The probability is equally distributed between the maximum and minimum values of the parameter.
- Minimum, mean value, maximum: The probability is equally distributed between the maximum, mean and minimum values of the parameter.

Additionally, a factor can be set for the deviation and an offset value between -1 and 1 can be used to shift horizontally the 'bell curve' in either direction.

The parameter 'Bearings tolerance' allows to vary the effective bearing clearance for each bearing in the system independently. For the given range 0 to 1 the bearing clearance is set to a random value between minimum and maximum effective clearance defined for each bearing. In parameter list or graphics always 0 is shown for the parameter. Please look at the results for effective bearing clearance instead.

Parameter list

The generation of the parameter list is performed as explained for the non-statistical parameter variation. By clicking on 'Calculate' a list of all parameter combinations will be generated at the corresponding tab window 'Parameter list' and the statistical analysis will be run. Depending on the chosen number of parameters and the specified number of calculations, the analysis can lead to long calculation times.

The parameter list shows the calculation results and allows to select result parameters available for graphics. Moreover, a whole table can be exported into a file using the -button. Please note that the any parameter list is not saved if the dialog is closed.

Graphics

On the tab-pages 'Graphics' any variable combination can be visualized in the form of point clouds, where the some trends for the relationship between the parameters might be recognized.

Distribution

The probability distribution is graphically represented at the tab-page 'Distribution'. By simply using the -button, it is possible to make comparisons of interest between the statistical results for different mechanical components in a system. As shown in the picture, the probability distribution of basic reference life for the different bearings mounted on the same shaft are compared with each other. The maxima of the curves are close to each other, but the variance for the roller bearing 'B2' is much larger. These analyses are useful to help identify restrictions or weaknesses in the design.

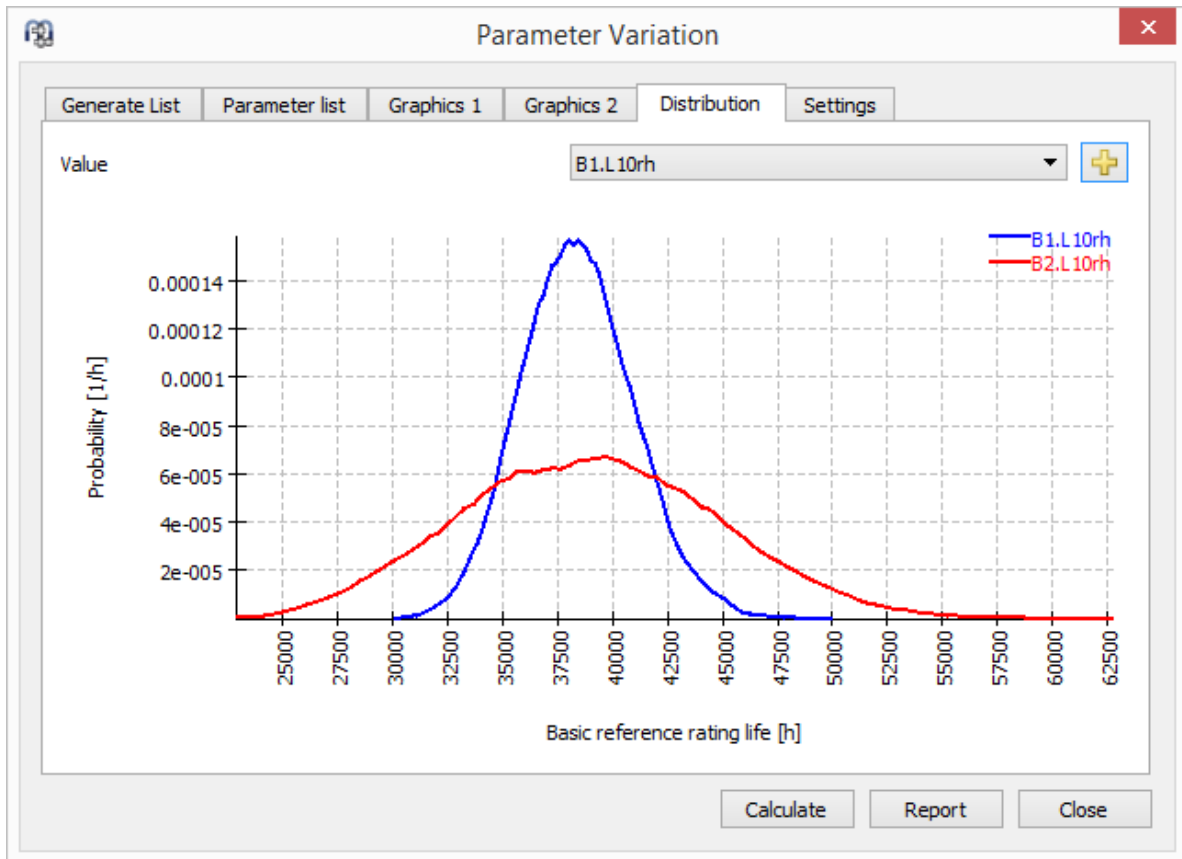

Report

You have to activate the checkbox “Include in report” if the graphic should be added to the report. The report will also show minimum, maximum, mean value and standard deviation for each selected result.

Interface to rolling bearing calculation

The dialogs of the MESYS Rolling Bearing Calculation are fully integrated into the shaft calculation.

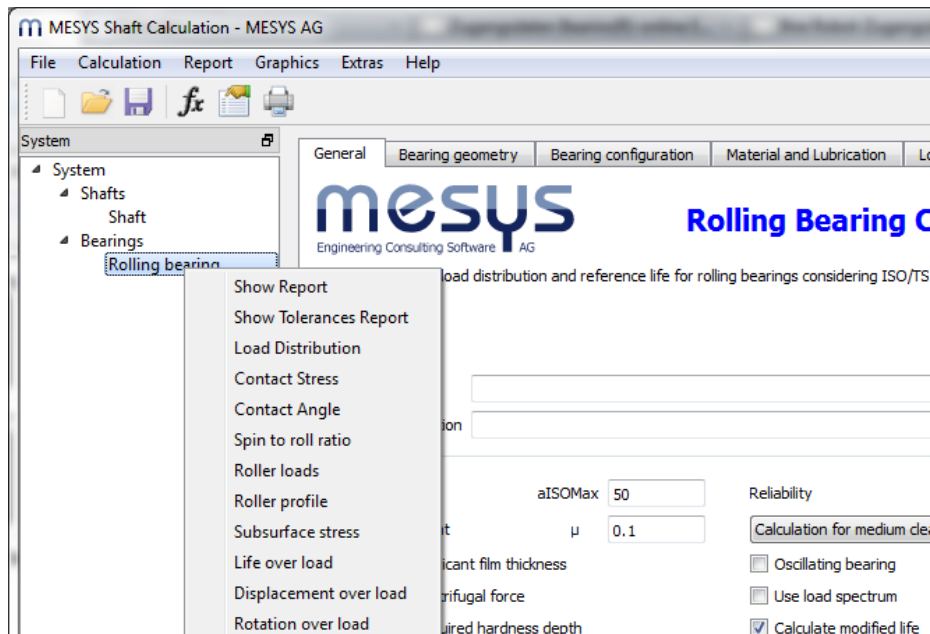

While the bearing calculation is open, the functions for file operations, calculation and report generation are used for the bearing calculation only. Therefore, only the bearing will be calculated and you will get results for the bearing in the results overview. However, it exists the possibility to run the whole shaft calculation, while the bearing calculation is in use, by pressing the key combination CTRL+F5.

Graphics and the tolerance report can be opened using the right mouse button in the system tree. Graphics are also available in the menu for graphics. Graphics from different bearings can be shown at the same time.

Interface to ball screw calculation

Add dialogs of the ball screw calculation are fully integrated into the shaft calculation like for the bearing calculation.

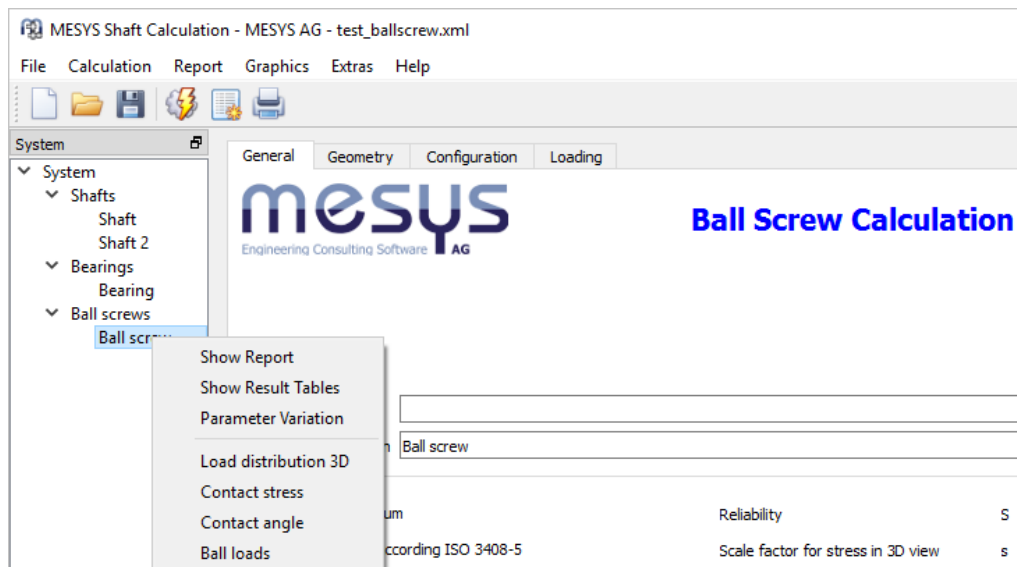

While the ball screw calculation is open, the functions for file operations, calculation and report generation are used for the ball screw calculation only. Therefore, only the ball screw will be calculated and you will get results for the ball screw in the results overview. However, it exists the possibility to run the whole shaft calculation, while the ball screw calculation is in use, by pressing the key combination CTRL+F5

Graphics and can be opened using the right mouse button in the system tree. Graphics are also available in the menu for graphics. Graphics from different ball screws can be shown at the same time.

Database

As database a SQLite database is used. In addition to the possibilities of the software also standard tools could be used to change the database. Please only add datasets with id > 100000 and do not modify datasets with id < 0 since they are used internally. On future versions datasets with id < 100000 might be changed or added.

In the current version there are database tables for Bearings, Material, Material Bearings, Material DIN 743 (DIN 743-3, Dezember 2012) and Lubrication. They can be added using the Menu 'Database' under 'Extras'.

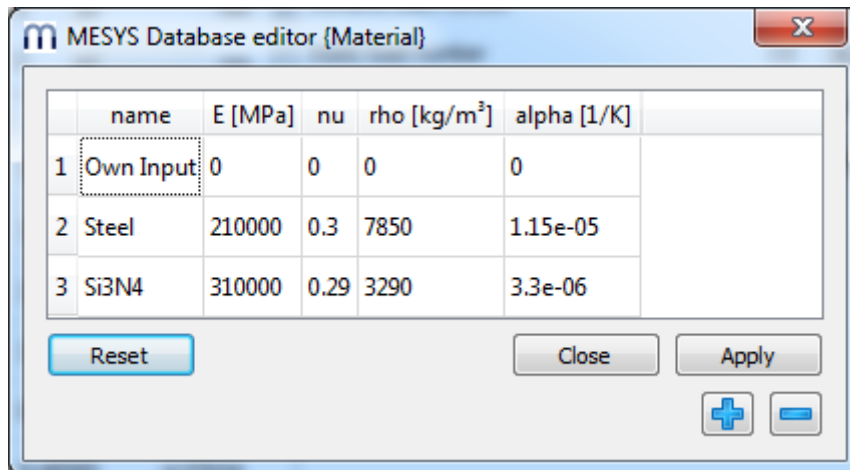

Data is written into the database only when clicking the Apply-Button, changes can be removed by selecting 'Reset' before 'Apply' is clicked.

Rows can be added using the -button or a selected row can be deleted using the -button.

Changing names in the database

When a calculation file is loaded, the software searches the database for combinations of id and name of a dataset. If the item is not found the inputs are changed to 'own input'.

Therefore, calculations files that are opened by other installations of the software with a different database, will show 'own input' and give the correct results.

If you change the name of entries in the database, the same will happen. You will see 'own input' in old files that used this entry and they will use the original data.

Adding bearings into the database

Under the Menu 'Extras' -> 'Database' -> 'Add bearing to the data base' a pop-up window with two tab-pages named "Bearing geometry" and "Material and Lubrication" is opened. These tab-pages operate in the same way as the ones in the bearing calculation interface. The feature offers the possibility to create and add a new bearing from scratch by entering all the required data or by selecting and modifying an existing bearing of the data base. In both cases, the user does not need to know in advance and the load capacity data, since the software finds it out from the required geometrical inputs when pressing the button "Calculate" at the bottom. Once all the data is filled, the "Apply" button must be pressed and the user will be prompted to enter a name for the new bearing.

Parameter	Value	Unit
Inner diameter (d)	20	mm
Outer diameter (D)	47	mm
Width (B)	14	mm
Number of rolling elements (Z)	7	
Diameter of rolling elements (Dw)	7.5	mm
Pitch diameter (Dpw)	33.5	mm
Conformity inner ring (fi)	0.52	
Conformity outer ring (fe)	0.52	
Shoulder diameter inner ring (dSi)	29	mm
Shoulder diameter outer ring (dSe)	38	mm

Parameter	Value	Unit
Dynamic load number (Cr)	10.6392	kN
Static load number (C0r)	5.27066	kN
Fatigue load limit (Cur)	0.274674	kN
Bearing clearance	User input as operating clearance	
Diametral clearance (Pd)	0	mm

The "Bearing comment" is optional and only used in the report. The "Mode for bearing in database" has the additional options for approximated geometry and hidden inner geometry. The later is used to create encrypted additional databases.

Results

Results are available in different outputs. There is the default result overview on the bottom of the user interface, an overview of bearing forces and natural frequencies, several graphics and the report.

Results Overview

The results overview on the bottom of the window shows minimal bearing life, minimum static bearing safety and maximum shaft deflection. The results overview can be configured under Extras->Results overview

Result Tables

Several result tables are available if the pages "Shafts", "Bearings" or a group is selected

Name	n [rpm]	ΣT [Nm]	ΣP [kW]	minL10rh [h]	minLnmrh [h]	pmax [MPa]	minSF	maxSigV [MPa]	SD	SS
Shaft 1	1000.00	15	1.5708	12781	11217	2305.04	6.05	59.08	1.86	21.48
Shaft 2	-327.27	45.8333	1.5708	19141	8357	2474.33	4.89	100.52	1.59	7.96
Shaft 3	69.30	216.435	1.5708	91155	13575	2410.75	5.29	78.55	2.50	11.39

Table for shafts

A table for shafts is showing shaft speed, sum of torque or power where only positive values are added, minimum bearing life, maximum bearing contact stress and shaft equivalent stress, minimum safety factors for shaft strength, maximum radial displacement and mass:

Name	n [rpm]	ΣT [Nm]	ΣP [kW]	minL10rh [h]	minLnmrh [h]	pmax [MPa]	minSF	maxSigV [MPa]	SD	SS	maxUr [mm]	mass [kg]	Jxx [kg mm ²]	Jyy [kg mm ²]	Jzz [kg mm ²]
S1	1000.00	100	10.472	3330	5121	2678.03	3.86	41.06	3.94	8.28	0.0380	1.38	196.17	4204.48	4204.48
S2	-395.35	252.941	10.472	2757	1931	2920.93	2.97	23.86	3.96	11.92	0.0506	3.09	1025.99	8636.34	8636.34
S3	149.35	669.55	10.472	5764	1685	2849.53	3.20	52.04	3.88	5.53	0.0334	4.06	1707.99	12817.2	12817.2

Table for sections

The table for sections shows details for each section for every shaft. The type of notch effect is shown, safety factors for strength, forces, moments and displacements:

Name	Type	x [mm]	SD	SS	Fx [kN]	Fy [kN]	Fz [kN]	Mx [Nm]	My [Nm]	Mz [Nm]	ux [mm]	uy [mm]	uz [mm]	rx [°]	ry [°]	rz [°]
▲ S1			3.94	8.28												
A	Shoulder	38	5.35	8.28	0.000	-1.034	-2.826	-100.00	-22.57	8.22	0.0048	-0.0107	-0.0282	1.20	0.01	-0.00
B	Shoulder	172	27.83	87.42	0.000	0.403	1.095	0.00	-8.74	3.20	0.0048	-0.0063	-0.0165	1.18	-0.02	0.01
C	Interference fit	55	4.47	10.46	0.000	-1.033	-2.826	-100.00	-70.61	25.78	0.0048	-0.0122	-0.0324	1.19	0.01	-0.00
D	Interference fit	95	3.94	12.44	0.000	0.361	0.995	-2.57	-93.09	34.06	0.0048	-0.0132	-0.0351	1.18	-0.00	0.00

Table for bearings

A table for bearings shows life and loading of bearings and supports. The sign convention for the loads is that the force from the shaft to the bearing is shown.

For rolling bearings the life and pressure is shown in addition to forces and moments. Using the right mouse button additional results like operating clearance or spin-to-roll ratio can be shown.

The screenshot displays the MESYS Shaft Calculation software interface. The main window shows a 3D model of a shaft and bearing assembly with a red arrow indicating a downward force. The left sidebar shows the system tree with 'Shafts' and 'Bearings' expanded. The central table provides detailed data for the shaft and bearings.

Name	L10rh [h]	Lnmrh [h]	pmax [MPa]	SF	Fx [kN]	Fy [kN]	Fz [kN]	Mx [Nm]	M
▲ HollowShaft									
left Bearing	12386.1	19876.5	2375.79	5.52	-2.179	-5.022	-0.000	0.00	-0.0
right Bearing	12386.1	19876.5	2375.79	5.52	2.179	-5.022	-0.000	0.00	0.0
▲ InnerShaft									
left Support					-0.000	-5.034	0.000	0.00	0.0
right Support					0.000	-5.034	0.000	0.00	0.0

The right side of the interface shows two bearing stress diagrams for the 'left Bearing' and 'right Bearing'. Each diagram displays a cross-section of the bearing with stress contours and labels for 'inner race' and 'outer race'. The maximum stress is indicated as 3000MPa.

The bottom section, 'Result overview', provides a summary of key results:

Minimal bearing reference life	minL10rh	12386.1	h	Minimal bearing modified reference life	minLnmrh	19876.5	h
Maximal bearing stress	pmax	2375.79	MPa	Minimal static safety for bearings	minSF	5.5249	
Maximal displacement in x	maxUx	0.00148658	mm	Maximal displacement in y	maxUy	0.0458852	mm
Maximal displacement in z	maxUz	0	mm	Maximal displacement in radial direction	maxUr	0.0458852	mm

Table for frequencies

In the overview also the natural frequencies can be shown. If a frequency is selected the corresponding mode is shown in the graphics. Three displacements and the torsion angle are shown in 2D view. In 3D view the mode shapes are shown animated.

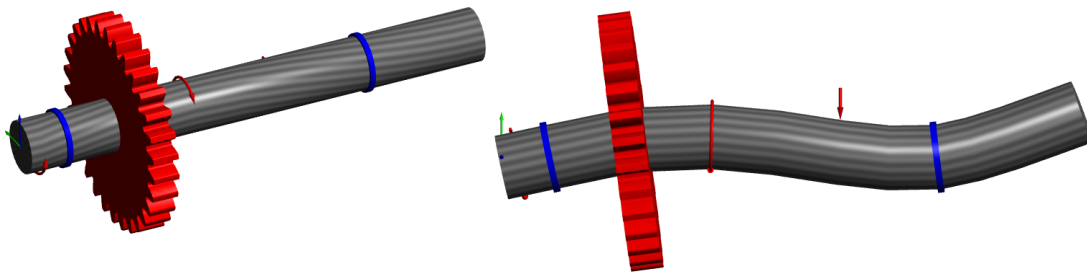
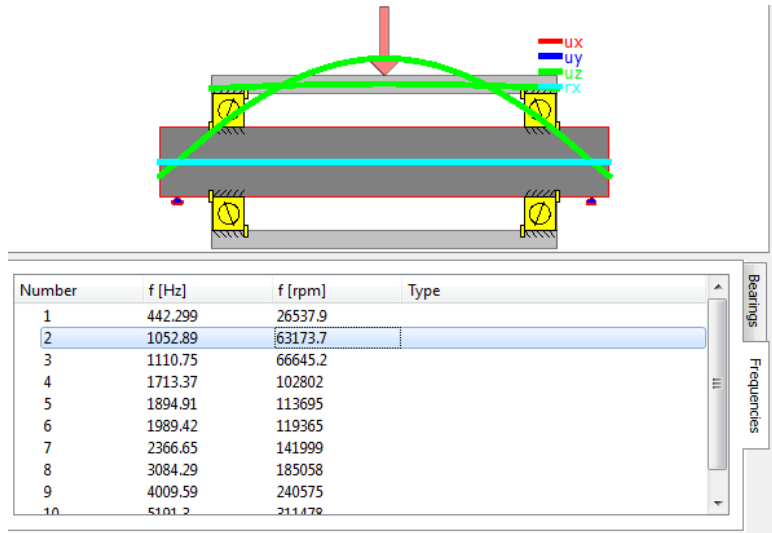

Report

Using the toolbar button or Report->Show Report a report for the shaft calculation is generated which only gives an overview for the bearing results.

There is also Report->Full report which is generating a full report with results of the shaft calculation and the full reports of the bearing calculations.

Report options

Using Report->Report options the contents of the report can be configured.

One page is available for outputs of the shaft calculation and one page for the bearing calculation. The settings for bearings are passed to the bearing calculation.

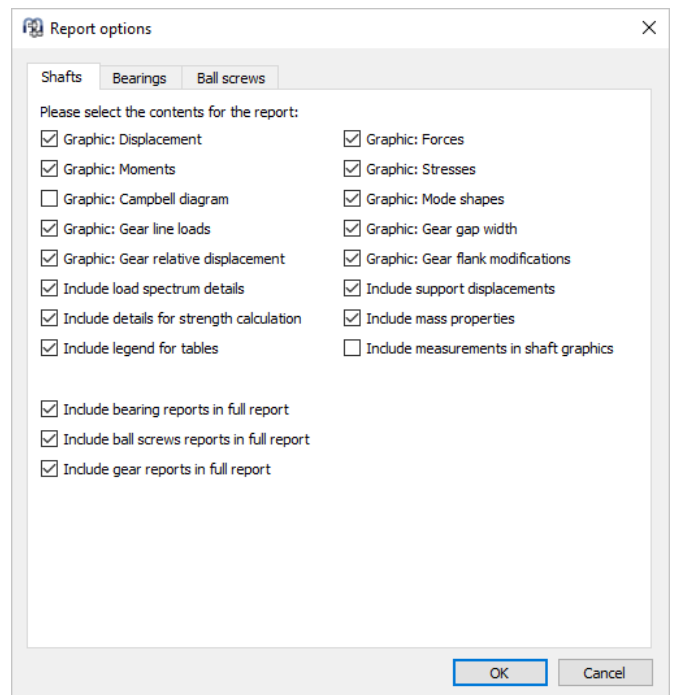

Result tables

In the menu Report->Result tables, it is possible to output the result data by means of tables, which can be generated in different file formats as explained before at "Configuration with INI-File".

Custom Report Templates

Custom report templates can be added in subdirectory "templates/shaft". Reports based on these templates can be generated by selecting the report template under Report->Report templates.

The report templates are word files with DOCVARIABLE fields. These fields are filled on generation of the report.

Possible fields are:

- DOCVARIABLE VAR name [unit]: the variable with the name 'name' is printed. Optionally a unit can be provided in brackets, for example [mm]. Additionally a format could be added like %6.3g or %6.3f, where 'f' always generates a fixed point output and 'g' generates an exponential output for large numbers.
- DOCVARIABLE VARU name [unit]: the variable with the name 'name' plus the unit are printed. Optionally a unit can be provided in brackets, for example [mm]
- DOCVARIABLE TABLE tablename: A table is inserted
- DOCVARIABLE GRAPHIC graphicName width=130 height=70: A graphic is inserted. Optionally height and width can be given in millimeters.

Regarding details for variable names, table names and graphic names please ask support@mesys.ch for additional documentation.

Graphics

For all diagrams diagram options are available using the right mouse button. It is possible to change coordinate system and units. Also export and printing is available in the context menu.

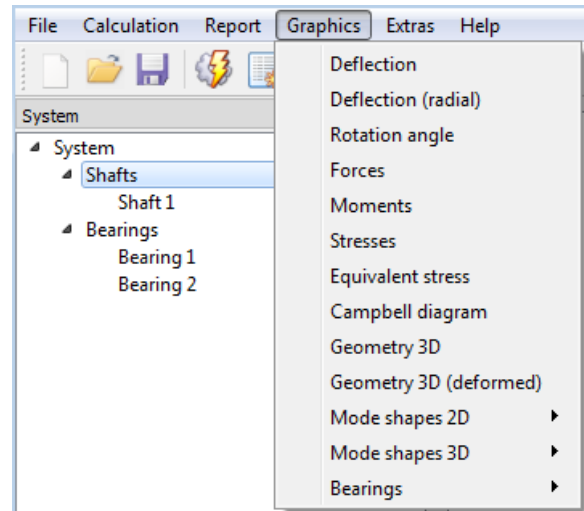

Shaft deflection

The deflection of the shafts is shown for the three displacement coordinates for each shaft.

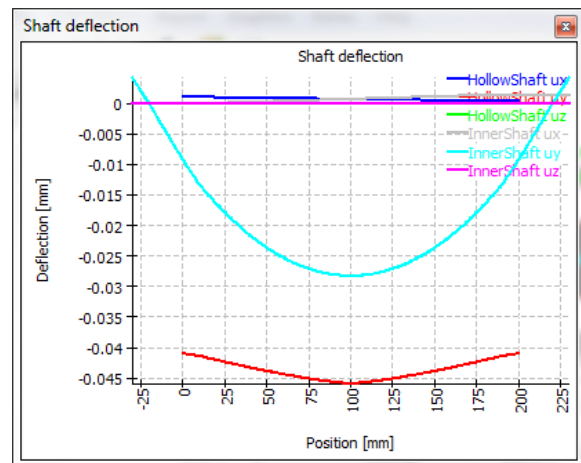

Shaft deflection (radial)

The radial deflection chart shows the absolute value of total radial deflection for the shafts.

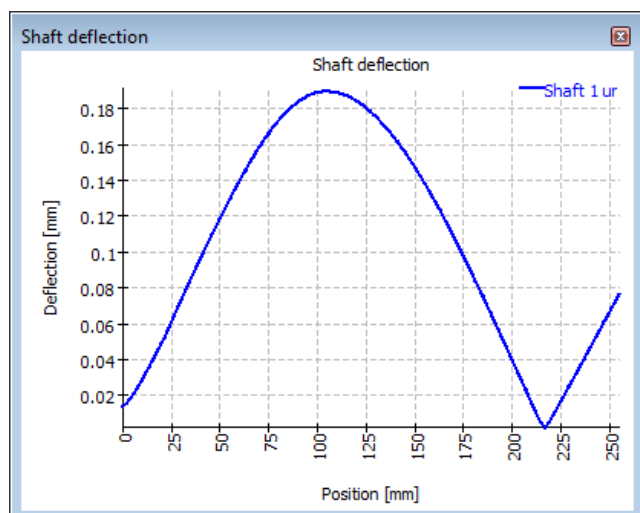

Shaft forces

The three force components are shown for each shaft.

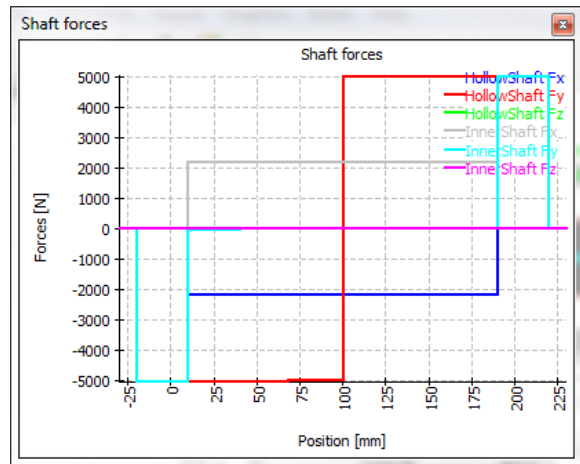

Shaft moments

The two bending moments and the torque are shown for each shaft.

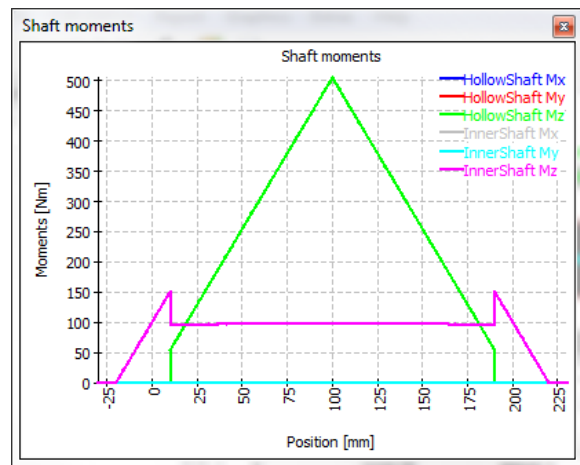

Shaft stresses

The stress components are shown for all shafts. Since there are too many curves in that diagram is several shafts are used there is also a diagram which only shows the equivalent stress.

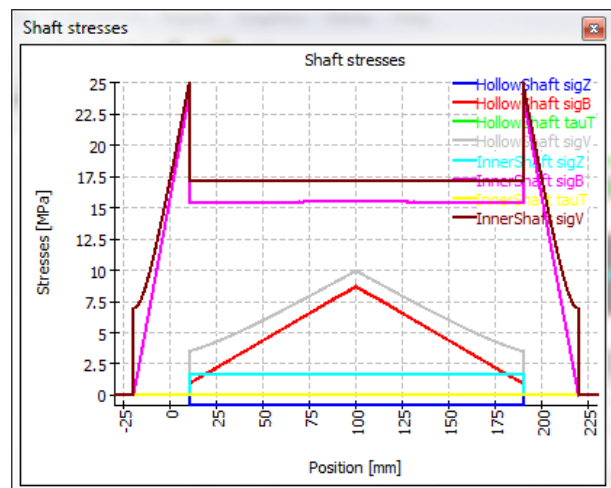
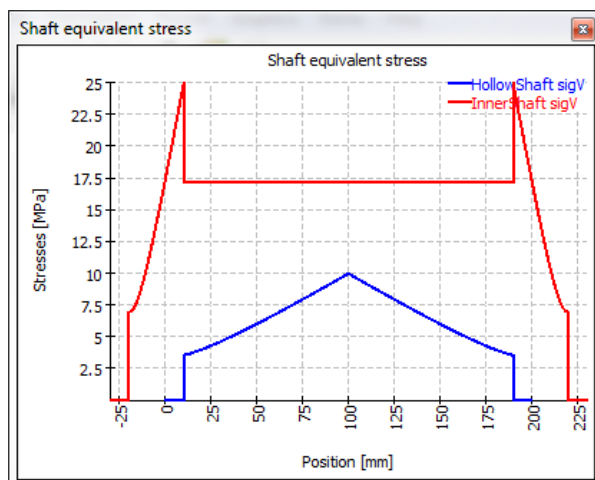

Campbell diagram

The Campbell diagram shows the change of natural frequencies over the shaft speed. The speed of all shafts is multiplied by the same factor in this calculation. The speed of the shafts is shown using dashed lines.

This calculation is always done considering the gyroscopic effect.

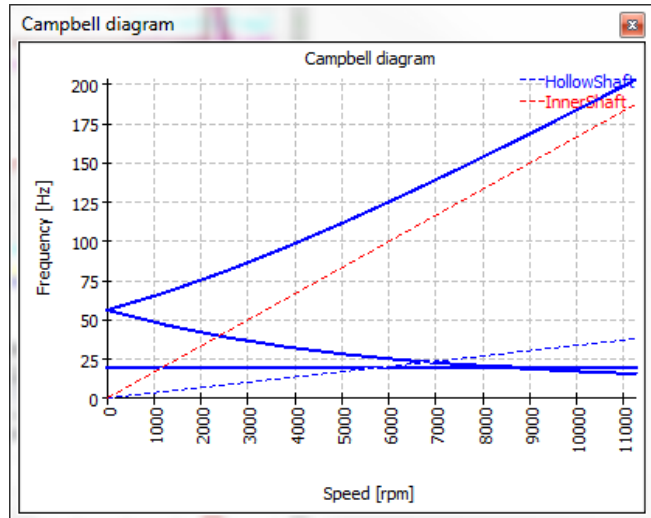

Harmonic response over speed

Harmonic response can be shown over speed. The calculation is done together with the Campbell diagram.

There are diagrams for forces available at all supports and diagrams for displacements available at positions of loads and sections of type "Documentation point"

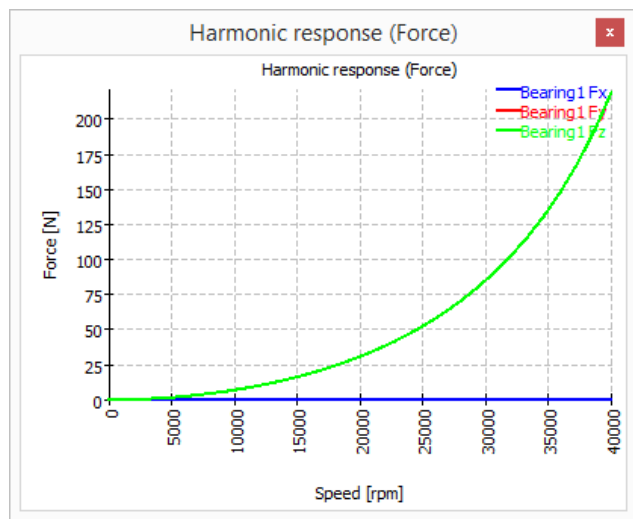

Harmonic response over time

Harmonic response over time is showing the variation of reaction forces and displacements over time. This calculation is done for the current rotation speed.

Harmonic response 3D

Harmonic response 3D is showing the dynamic displacements over time as 3D view.

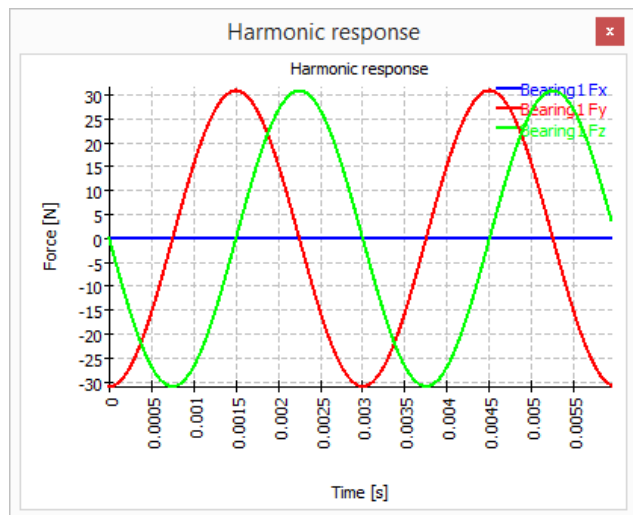

Diagrams for bearing analysis

In addition, there are several diagrams for bearing analysis. Please check the documentation of the bearing analysis for details.

Bearing overviews

Several graphics for bearings are available as overview graphics, showing the same diagram for each bearing. This allows to get a quick overview over the behavior of all bearings.



Bearing system reliability

The system reliability considering all bearings is shown in a diagram

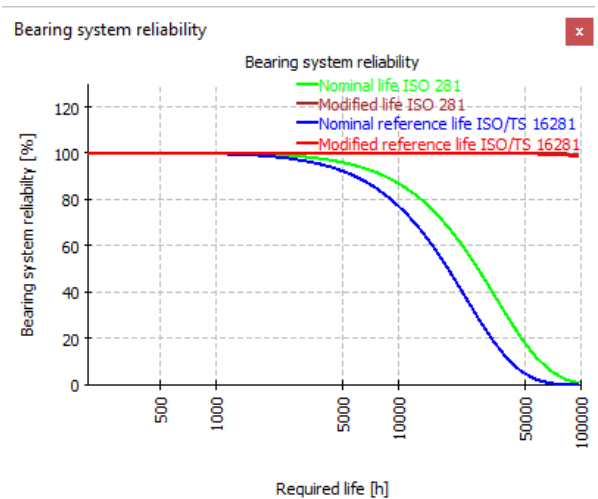

Geometry 3D

The 3D geometry can be shown without deformations or with exaggerated deformations. The diagram is available for the whole systems and for each group.

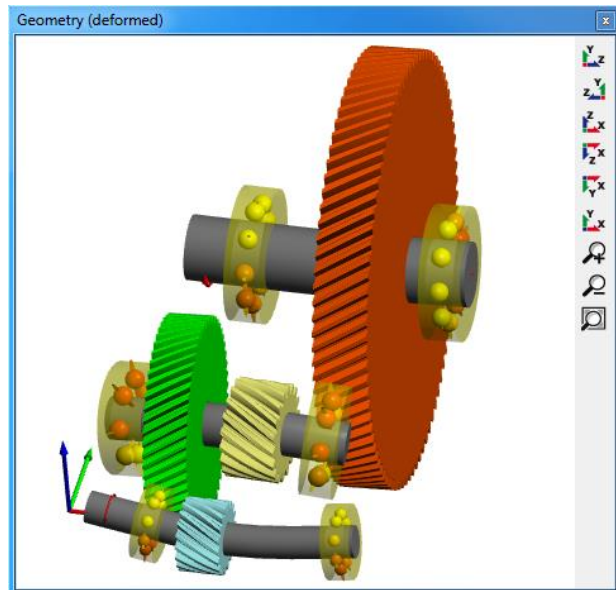

Geometry 3D (power flow)

The power flow of transmission systems can be shown in the 3D graphics.

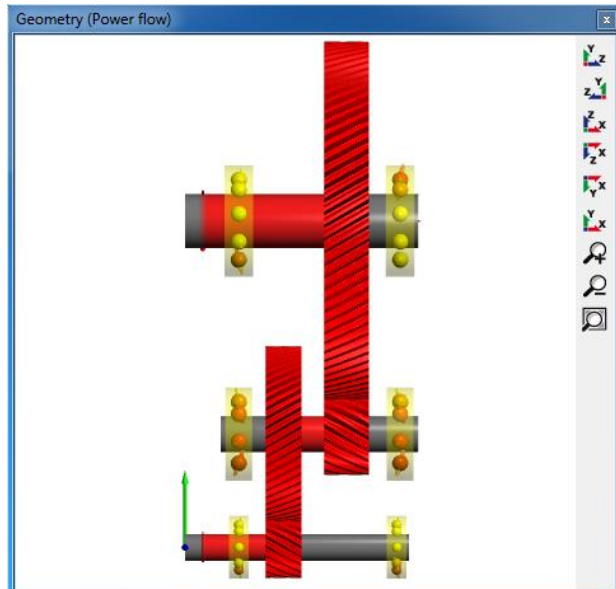

Gear line load and gap width

The line load on a gear pair can be shown and also the gap width. For these diagrams either the gears should be considered as stiffness under settings or the shaft diameter has to be large enough to take into account the stiffness of the gear body. The gap width can be used for a proposal of flank line corrections. Both diagrams are also available for load spectra showing results for all elements.

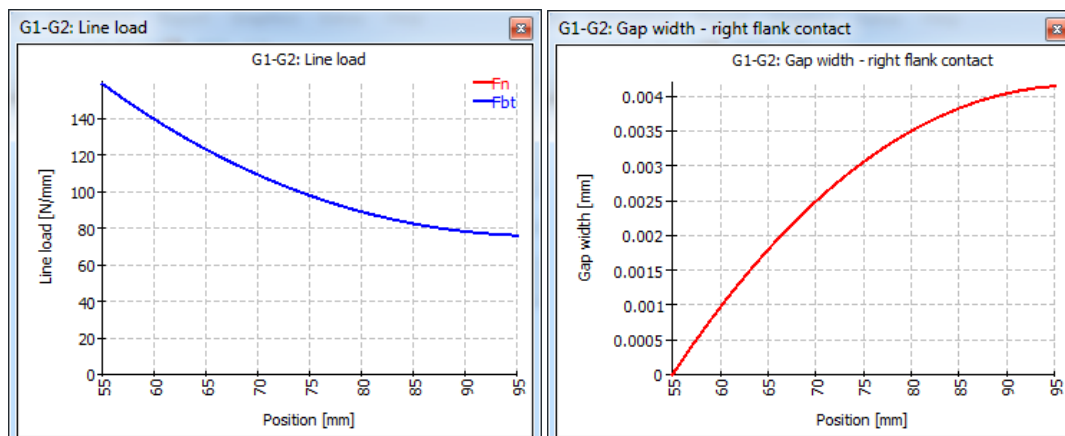

Tooth flank modifications

It shows the resulting profile of the tooth flank from the corrections applied in order to obtain an optimum tooth contact. In this way, the x-axis represents the tooth width in mm and the y-axis the geometrical variation in μm which has been undergone by the flank.

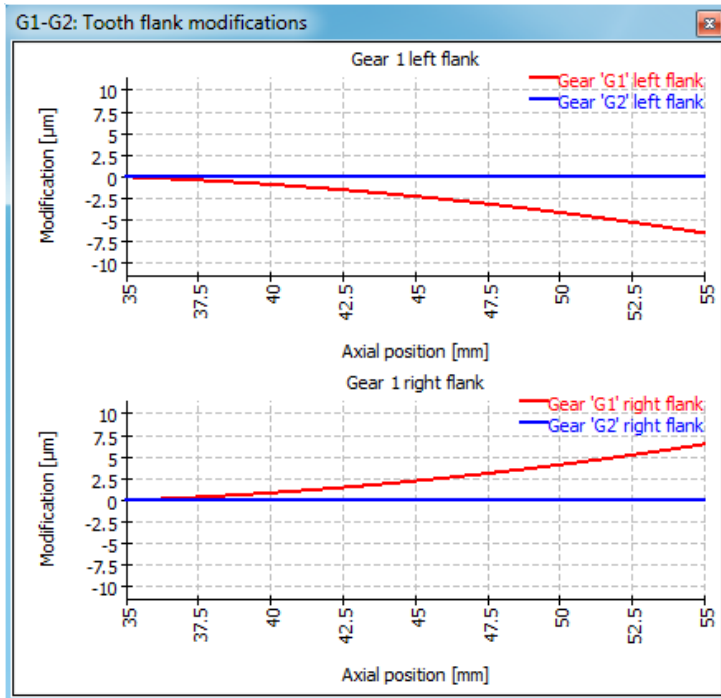

Relative displacements

A diagram for relative displacement of shafts is shown for each cylindrical gear pair. It shows the relative displacement of both shafts over the width of the gears. The axial displacement is a change of the center distance, the normal displacement a translation normal to the plane of the two shafts.

The diagram helps to understand required modifications or changes or clearance.

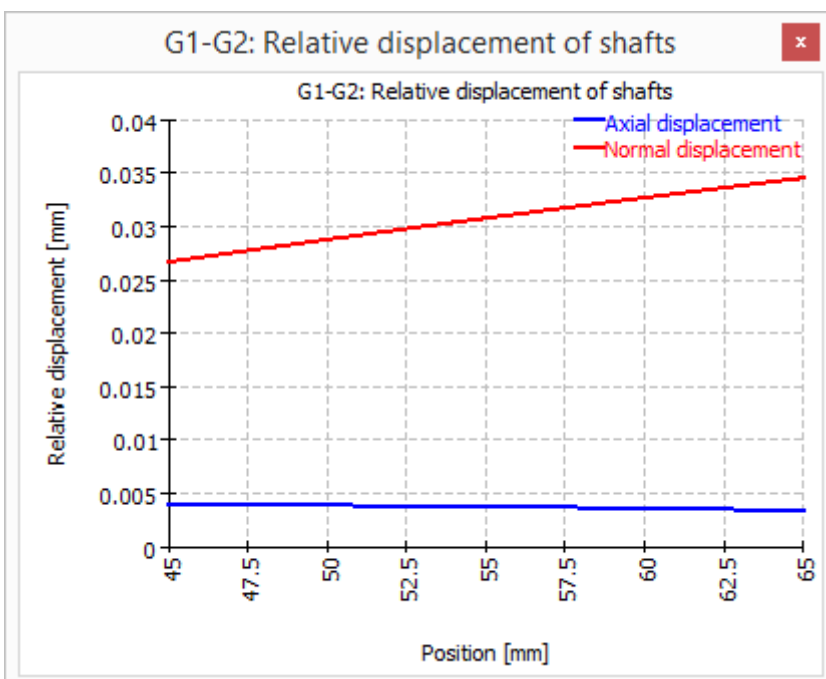

Graphics area

By right-clicking the main graphics area in 2D mode, a context menu called 'Diagram' offers the possibility of overlaying some shaft-related diagrams on the actual geometry of the shaft.

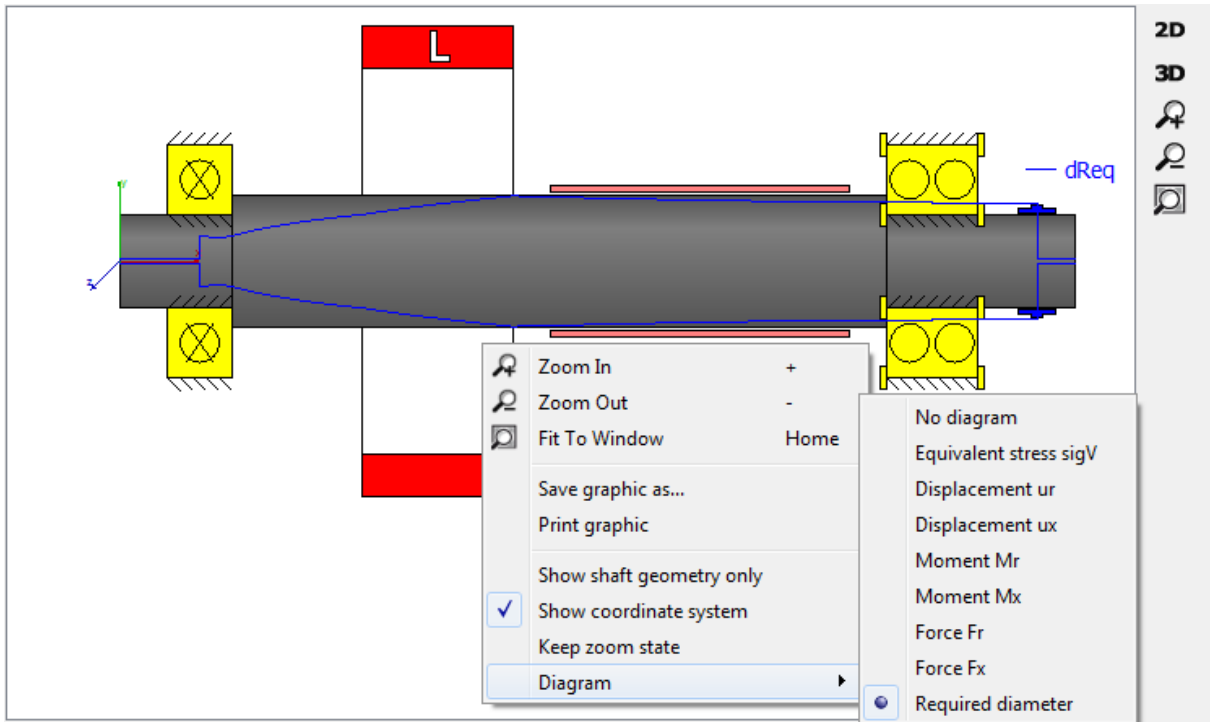

Required diameter

Apart from all the aforementioned graphics in the previous section, an additional diagram called 'Required diameter' can be overlaid to the 2D geometry of the shaft. It provides a clue as to how the size of the diameter should be in order not to exceed a maximum equivalent stress value (see the image above), which is defined under the tab-page 'Display settings'.

Bibliography

Cowper., G. R. June 1966. The Shear Coefficient in Timoshenko's Beam Theory. *Journal of Applied Mechanics – Transactions of the ASME*. June 1966.

DIN 743-1. Dezember 2012. *Tragfähigkeitsberechnung von Wellen und Achsen - Grundlagen*. s.l. : DIN, Dezember 2012.

DIN 743-2. Dezember 2012. *Tragfähigkeitsberechnung von Wellen und Achsen - Formzahlen und Kerbwirkungszahlen*. s.l. : DIN, Dezember 2012.

DIN 743-3. Dezember 2012. *Tragfähigkeitsberechnung von Wellen und Achsen - Werkstoff-Festigkeitswerte*. s.l. : DIN, Dezember 2012.

DIN 743-4. Dezember 2012. *Tragfähigkeitsberechnung von Wellen und Achsen - Schädigungsäquivalente Spannungsamplitude*. s.l. : DIN, Dezember 2012.

Hutchinson, J. R. January 2001. Shear Coefficients for Timoshenko Beam Theory. *Journal of Applied Mechanics – Transactions of the ASME*. January 2001.

ISO 21771:2007. September 2007. *Gears – Cylindrical involute gears and gears pairs – Concepts and Geometry*. s.l. : ISO, September 2007.

ISO 7902-1. November 2013. *Hydrodynamic plain journal bearings under steady-state conditions - Calculation procedure - Second edition*. s.l. : ISO, November 2013.

ISO 7902-2. May 1998. *Hydrodynamic plain journal bearings under steady-state conditions - Functions used in the calculation procedure - Second edition*. s.l. : ISO, May 1998.

ISO 7902-3. July 1998. *Hydrodynamic plain journal bearings under steady-state conditions - Permissible operational parameters - Second edition*. s.l. : ISO, July 1998.